

Recommended PCB Layout(Top View)

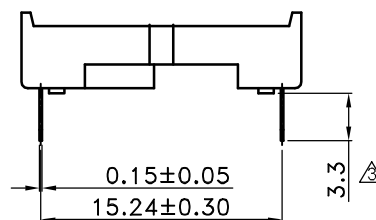
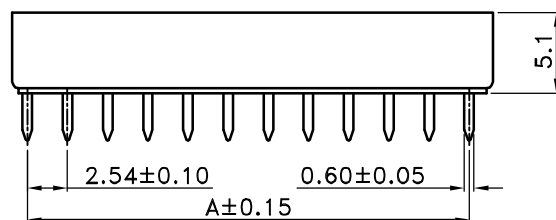
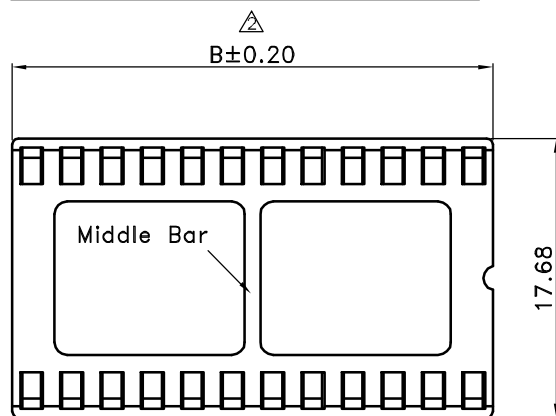

■ SPECIFICATIONS

- Current Rating : 1A AC/DC
- Withstanding Voltage : 1,000V AC/minute
- Insulation Resistance : 1,000MΩ min
- Temperature Range : - 40°C to + 105°C
- Contact Resistance : 20mΩ max

■ Feature:

- Part Type : IC SOCKET(With Middle Bar)
- Part No. : JS-1179F-XX
- Poles : 24~48
- Material :
 1. Contact : Phos. Bronze
 2. Base : PBT UL94V-0
- Plated : Tin Plated
- Packing : Tube

Poles	Dimensions(mm)	
	A	B
24	27.94	30.38
28	33.02	35.46
32	38.10	40.54
40	48.26	50.70
42	50.80	53.24
48	58.42	60.86



喬訊電子工業股份有限公司
CHYAO SHIUNN
ELECTRONIC INDUSTRIAL LTD.

APPROVED BY	SCALE	UNIT	TOLERANCE	LTR	REVISION RECORD	NAME	DATE	LTR	REVISION RECORD	NAME	DATE
Tom Shih		mm	.0 ±0.30	△	增加Layout及寬、窄版敘述	黃科源	09/01/15				
CHECKED BY	PROJ	VER NO.	.00 ±0.20	△	修改公差值	王誠賢	10/09/29				
Erin Chou	⊕	a4	.000 ±0.10	△	修正尺寸標註	Eddie	23/09/26				
DRAWN BY	DATE	SIZE	ANGLE					CUSTOMER			
Eddie	2023/09/26	A4	0° ±1°					Conforms to The RoHS Instruction			
			0° ±								
			SHEET	1/1							

PART NO JS-1179F-XX
2.54mm IC Socket, Wide Base Type

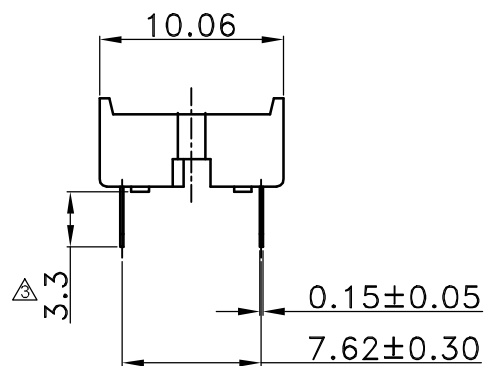
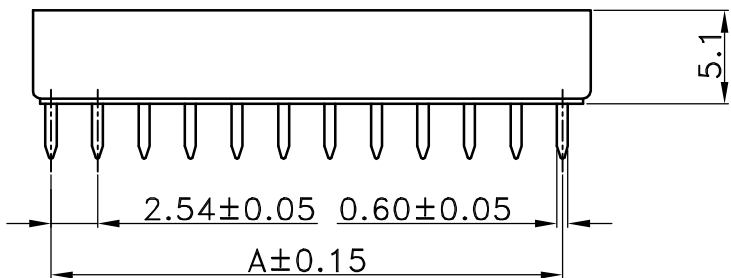
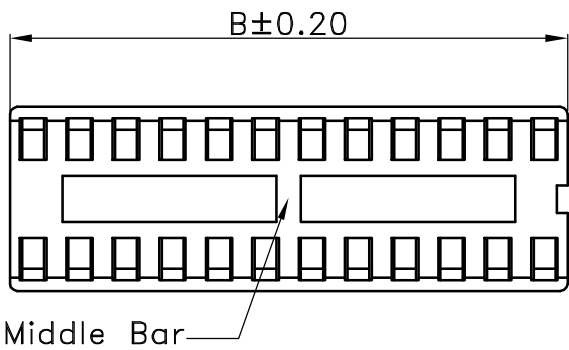
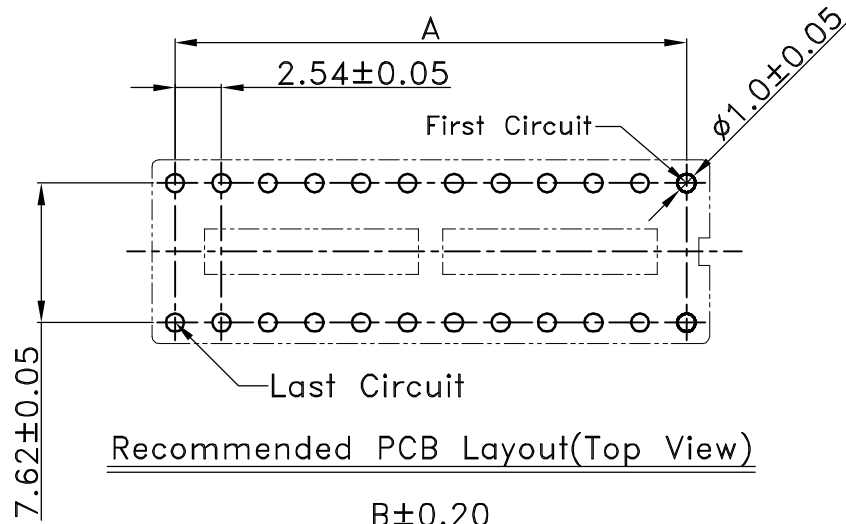

■ SPECIFICATIONS

- Current Rating : 1A AC/DC
- Withstanding Voltage : 1,000V AC/minute
- Insulation Resistance : 1,000MΩ min
- Temperature Range : - 40°C to + 105°C
- Contact Resistance : 20mΩ max

■ IC SOCKET

- Part No. : JS-1179FN1-XX (With Middle Bar)
- Poles : 24~32
- RoHS Compliant 2002/95/EC
- Material :
 - 1.Contact : Phos. Bronze
 - 2.Base : PBT UL94V-0
- Finish : Tin Plated
- Q' ty : 1,000 pcs./Tube Pack

Poles	Dimensions (mm)	
	A	B
24	27.94	30.38
28	33.02	35.46
32	38.10	40.54



喬訊電子工業股份有限公司
CHYAO SHIUNN
ELECTRONIC INDUSTRIAL LTD.

APPROVED BY	SCALE	UNIT	TOLERANCE	LTR	REVISION RECORD	NAME	DATE	LTR	REVISION RECORD	NAME	DATE
Tom Shih		mm	.0 ±0.30	▲	塑膠本體尺寸修改	王誠賢	09/01/15				
CHECKED BY	PROJ	VER NO.	.00 ±0.20	▲	尺寸對照表修正	王誠賢	10/06/07				
Erin Chou	⊕	a3	.000 ±0.10	▲	更新圖框，修正尺寸標註	Eddie	23/09/26				
DRAWN BY	DATE	SIZE	ANGLE					CUSTOMER			
Eddie	2023/09/26	A4	0° ±1°					Conforms to The RoHS Instruction			
			0° ±								
SHEET			1/1								

PART NO | JS-1179F-XXN
2.54mm IC Socket, Wide Base Type

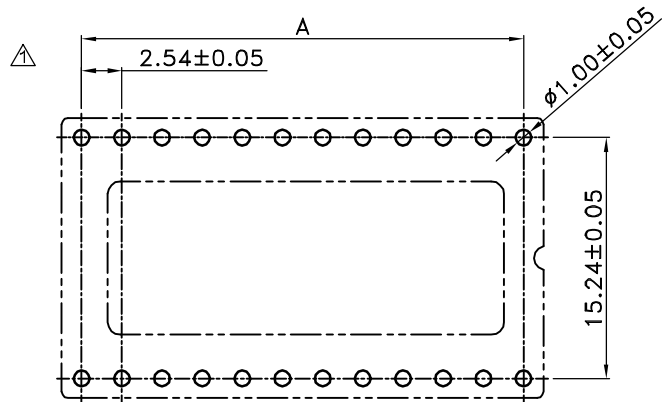

Recommended PCB Layout(Top View)

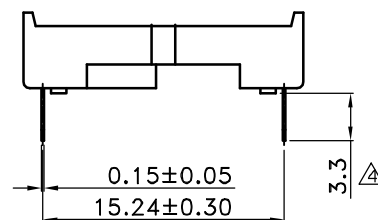
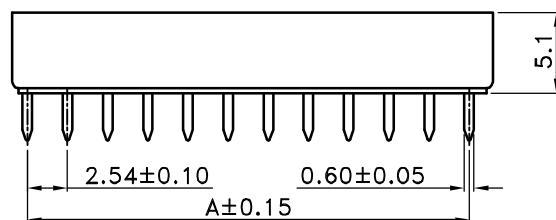
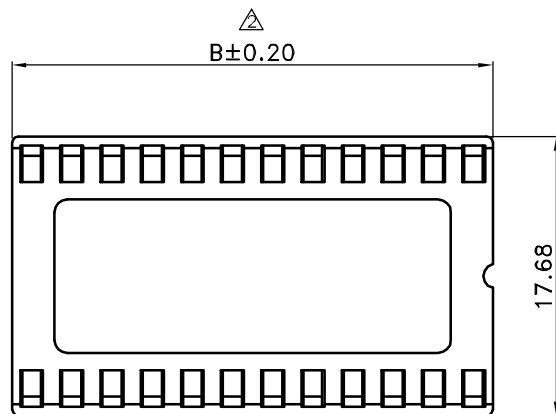

■ SPECIFICATIONS

- Current Rating : 1A AC/DC
- Withstanding Voltage : 1,000V AC/minute
- Insulation Resistance : 1,000MΩ min
- Temperature Range : - 40°C to + 105°C
- Contact Resistance : 20mΩ max

■ Feature:

- Part Type : IC SOCKET (Without Middle Bar)
- Part No. : JS-1179F-XXN
- Poles : 24~40
- Material :
 1. Contact : Phos. Bronze
 2. Base : PBT UL94V-0
- Plated : Tin Plated
- Packing : Tube

Poles	Dimensions(mm)	
	A	B
24	27.94	30.38
28	33.02	35.46
32	38.10	40.54
40	48.26	50.70



喬訊電子工業股份有限公司
CHYAO SHIUNN
ELECTRONIC INDUSTRIAL LTD.

APPROVED BY	SCALE	UNIT	TOLERANCE	LTR	REVISION RECORD	NAME	DATE	LTR	REVISION RECORD	NAME	DATE
Tom Shih		mm	.0 ±0.30	△	修正物性表敘述	林文彬	06/11/03				
CHECKED BY	PROJ	VER NO.	.00 ±0.20	△	增加Layout及寬、窄版敘述	黃科源	09/01/15				
Erin Chou	⊕	a5	.000 ±0.10	△	修改公差值	王誠賢	10/09/29				
DRAWN BY	DATE	SIZE	ANGLE		△	修正尺寸標註	Eddie	23/09/26	CUSTOMER		
Eddie	2023/09/26	A4	0° ±1°						Conforms to The RoHS Instruction		
			0° ±								
			SHEET	1/1							

PART NO JS-1179F-XXN
2.54mm IC Socket, Wide Base Type