

JS-23158A-02

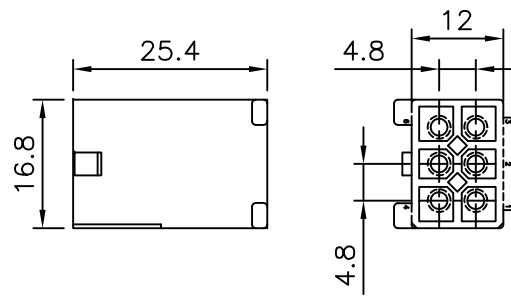

JS-23158A-06

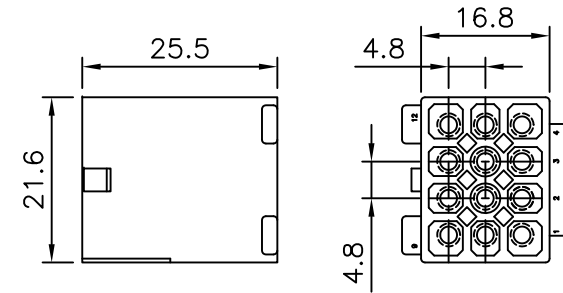

JS-23158A-12

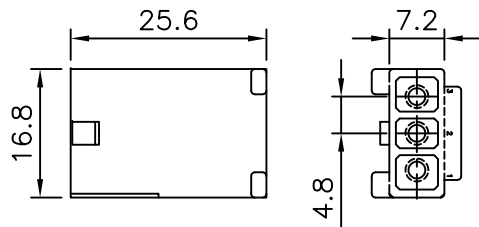

JS-23158A-03

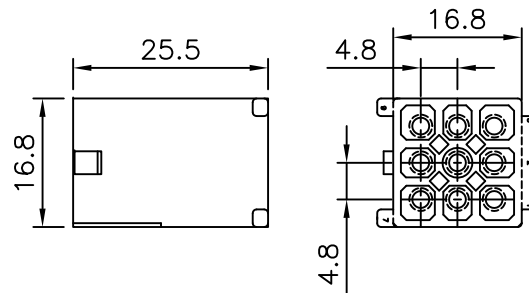

JS-23158A-09

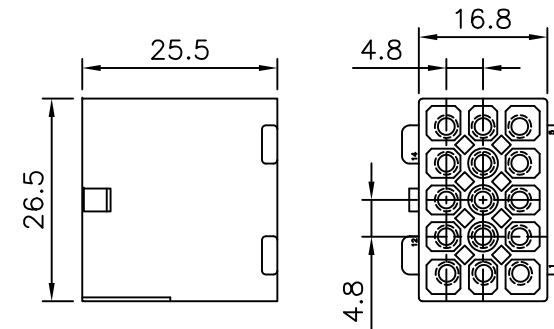

JS-23158A-15

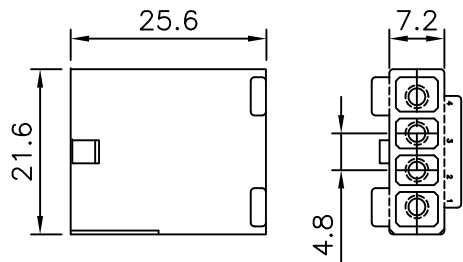

JS-23158A-04

■ SPECIFICATIONS

- Voltage Rating : 250 V AC/DC
- Current Rating : 5 A AC/DC
- Withstanding Voltage : 1,500V AC/minute
- Insulation Resistance : 1,000M Ω min
- Temperature Range : - 40°C to + 105°C

■ HOUSING

- Part No. : JS-23158A-XXX
JS-23158A-XX : GP Produces
JS-23158A-0XX : Non GP Produces
- Poles : 2, 3, 4, 6, 9, 12, 15
- Material : Nylon 66 UL94V-2
- Q' ty : 1,000 pcs./Bag

 喬訊電子工業股份有限公司 CHYAO SHIUNN ELECTRONIC INDUSTRIAL LTD.	APPROVED BY	SCALE	UNIT	TOLERANCE		LTR	REVISION RECORD	DATE
	林陳鏞	1:1	mm	.0	±0.3			
PART NO	JS-23158A-XX	CHECKED BY	PROJ	VER NO.	.00			
		林勇生			.000			
ø1.58mm Power Connectors Housing		DRAWN BY	DATE	SIZE	ANGLE			
		邱森鴻	2004/12/31	A4	0°	±		
					.0°	±		

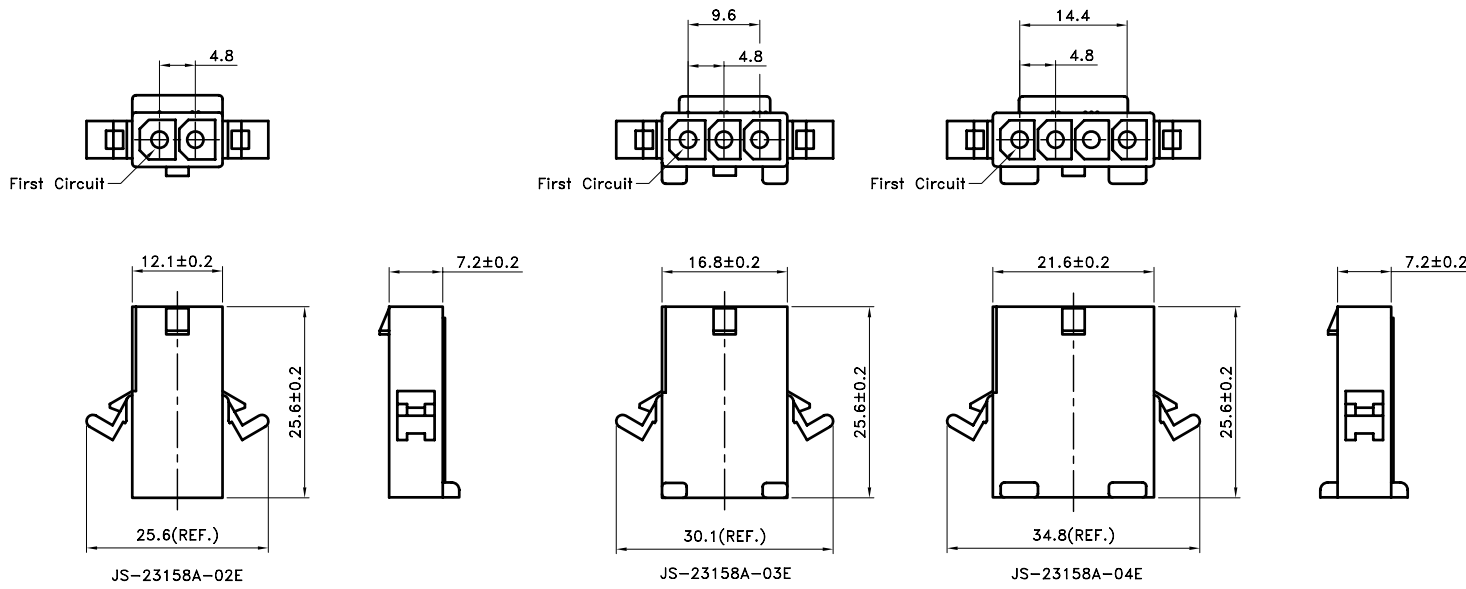



■ SPECIFICATIONS

- Voltage Rating : 250 V AC/DC
- Current Rating : 5 A AC/DC
- Withstanding Voltage : 1,500V AC/minute
- Insulation Resistance : 1,000MΩ min
- Temperature Range : - 40°C to + 105°C

■ RECEPTACLE HOUSING

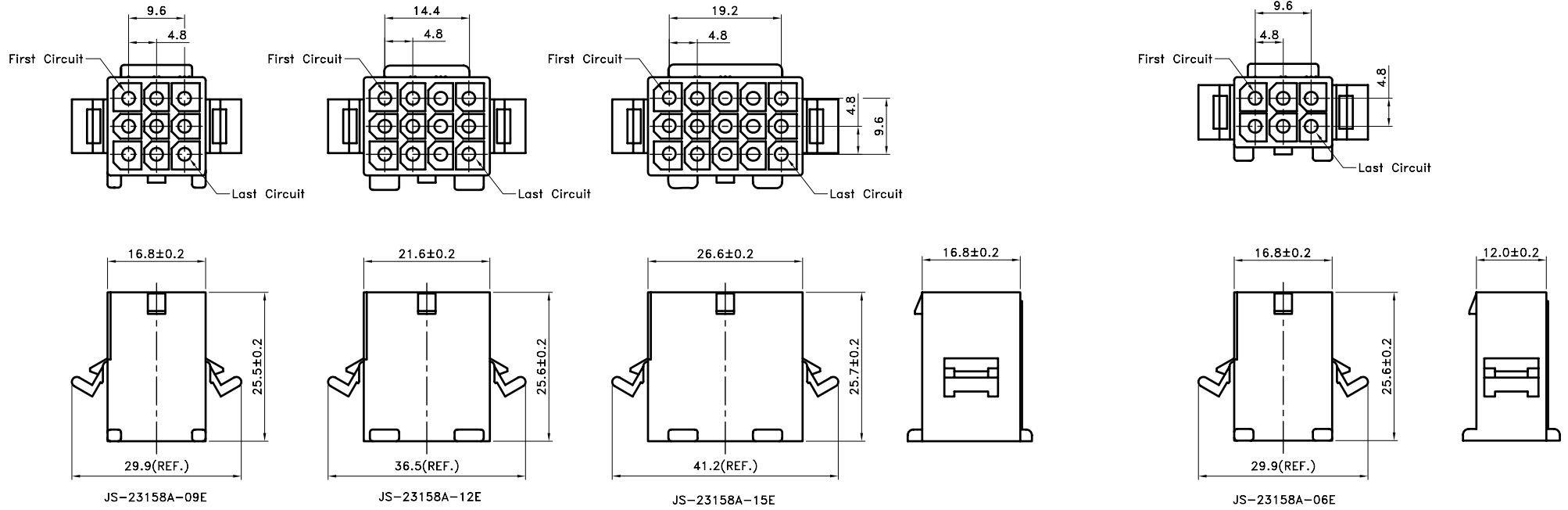
- Part No. : JS-23158A-XXxE
- Poles : Single Row : 2, 3, 4
Double Row : 6
Triple Row : 9, 12, 15
- Material : Nylon 66 UL94V-2
- Q' ty : 1,000 pcs./Bag



 喬訊電子工業股份有限公司 CHYAO SHIUNN ELECTRONIC INDUSTRIAL LTD.	APPROVED BY	SCALE	UNIT	TOLERANCE		LTR	REVISION RECORD	DATE	LTR	REVISION RECORD	DATE
	林宗		mm	.0	±0.3	ECR	RoHS Compliant	06/04/01			
PART NO JS-23158A-XXE ø1.58mm Power Connectors Receptacle Housing	CHECKED BY	PROJ	VER NO.	.00	±0.2	ECR	200905-001	09/05/07			
	DRAWN BY	DATE	SIZE	.000	±0.1				CUSTOMER		
黃科源	2009/05/7	A4	ALL	±							
				ANGLE						Conforms to The RoHS Instruction	
				0°	±						
				.0°	±						

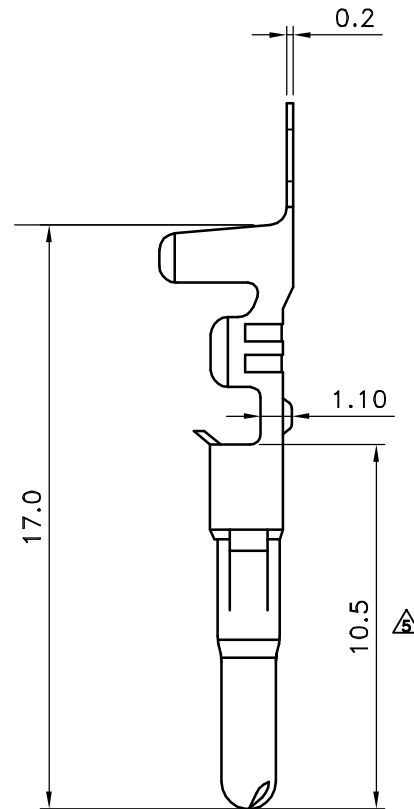
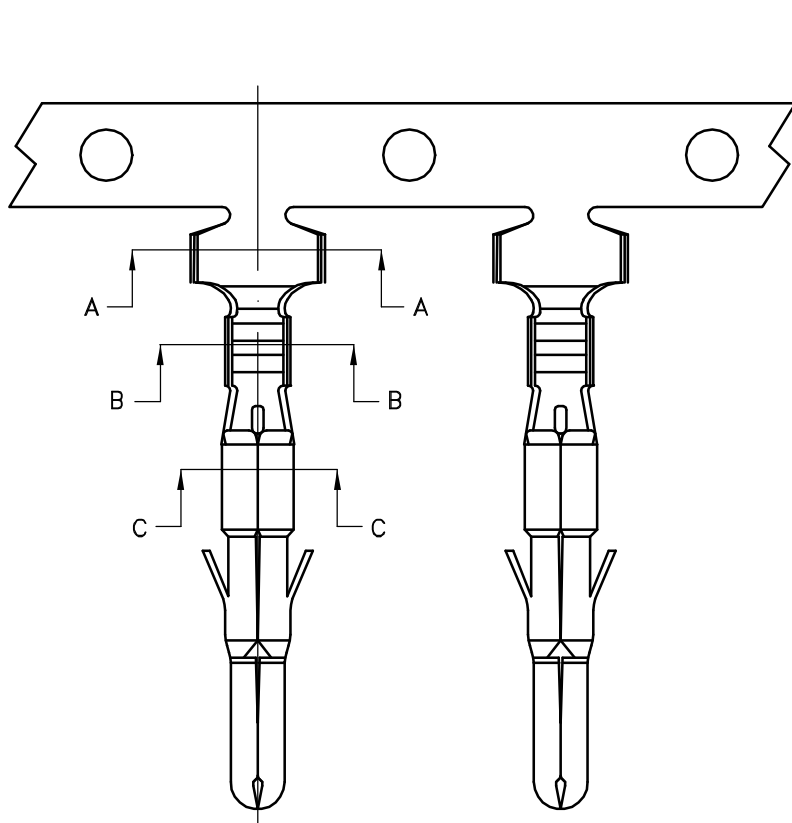

- **SPECIFICATIONS**
- Voltage Rating : 250 V AC/DC
 - Current Rating : 5 A AC/DC
 - Withstanding Voltage : 1,500V AC/minute
 - Insulation Resistance : 1,000M Ω min
 - Temperature Range : - 25 $^{\circ}$ C to + 105 $^{\circ}$ C
 - Contact Resistance : 20m Ω max

- **TERMINAL**
- Part No. : JS-23158BS-2
 - Applicable Wires : AWG # 18 - 24
 - Material : Brass
 - Finish : Tin Plated
 - Thickness : 0.2 mm
 - Q' ty : 7,000 pcs./Reel

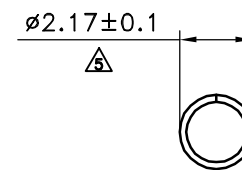
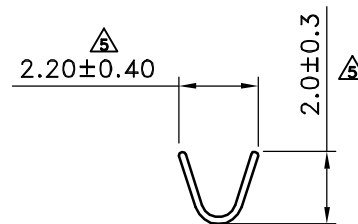
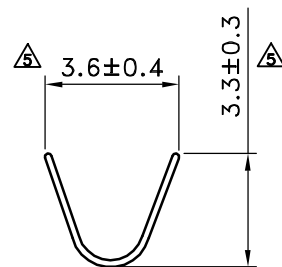
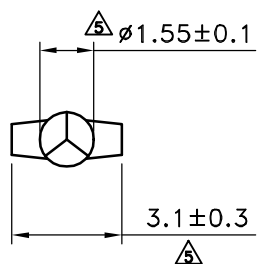

A-A SEC

B-B SEC

C-C SEC

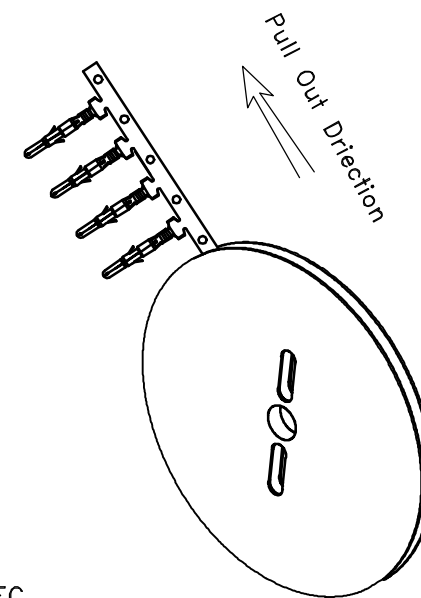

喬訊電子工業股份有限公司
CHYAO SHIUNN
ELECTRONIC INDUSTRIAL LTD.

APPROVED BY	SCALE	UNIT	TOLERANCE	LTR	REVISION RECORD	NAME	DATE	LTR	REVISION RECORD	NAME
Tom Shih		mm	.0 ±0.30	▲	ECR200612-002	林文彬	2006/12/20	▲		
CHECKED BY	PROJ	VER NO.	.00 ±0.20	▲	ECR200905-004	黃科源	2009/05/07	▲		
Erin Chou		a5	.000 ±0.10	▲	增加端子繞向圖	吳弘文	2014/10/23	▲		
DRAWN BY	DATE	SIZE	ANGLE		修正物性表規格	吳弘文	2014/12/31	CUSTOMER		
Eddie	2023/02/22	A4	0° ±1°	▲	修正尺寸	Eddie	2023/02/22			
			.0° ±	▲				Conforms to The RoHS Instruction		
			SHEET	1/1						

PART NO JS-23158BS-2

Ø1.58mm Power Connectors Terminal

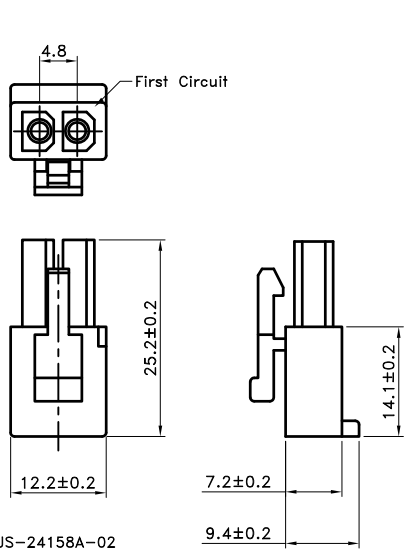

JS-24158A-02

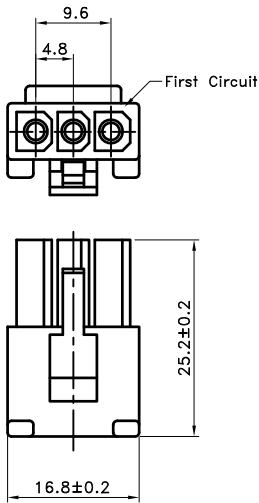

JS-24158A-03

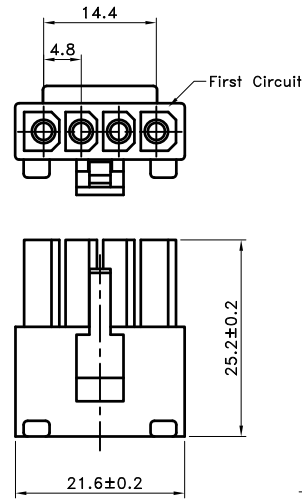

JS-24158A-04

■ SPECIFICATIONS

- Voltage Rating : 250 V AC/DC
- Current Rating : 5 A AC/DC
- Withstanding Voltage : 1,500V AC/minute
- Insulation Resistance : 1,000M Ω min
- Temperature Range : - 40°C to + 105°C

■ PLUG HOUSING

- Part No. : JS-24158A-XX
- Poles : Single Row : 2, 3, 4,
Double Row : 6,
Triple Row : 9, 12, 15
- Material : Nylon 66 UL94V-2
- Q' ty : 1,000 pcs./Bag

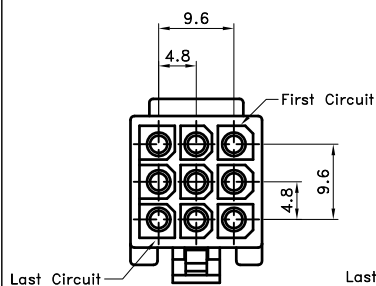

JS-24158A-09

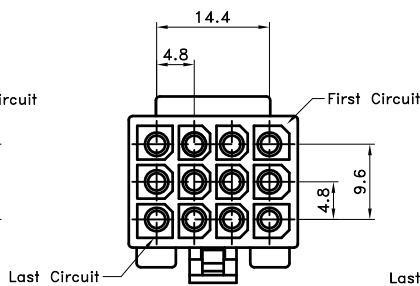

JS-24158A-12

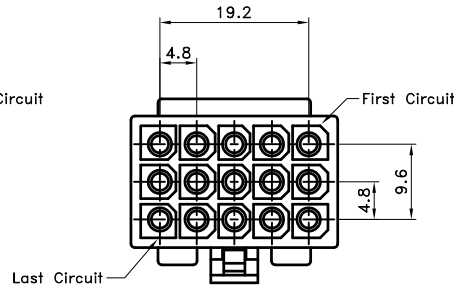

JS-24158A-15

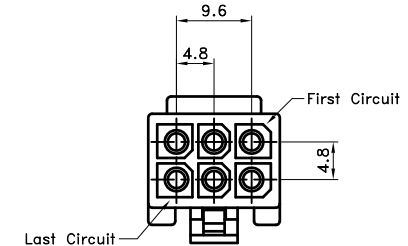

JS-24158A-06

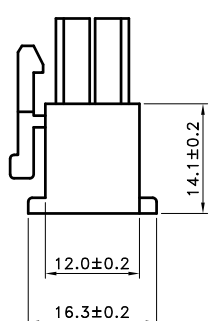
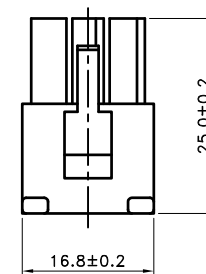
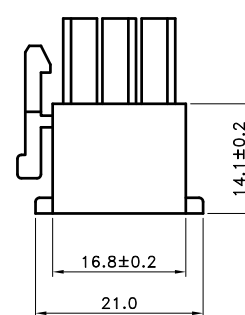
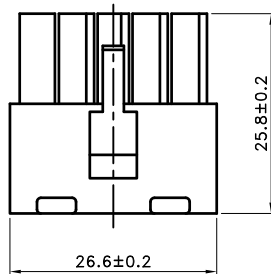
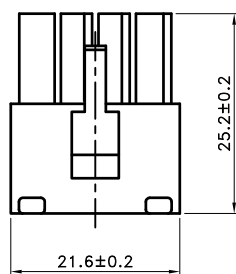
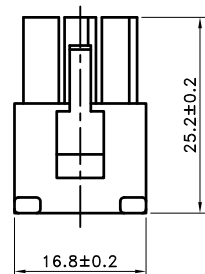

 喬訊電子工業股份有限公司
CHYAO SHIUNN
ELECTRONIC INDUSTRIAL LTD.

PART NO JS-24158A-XX

∅1.58mm Power Connectors Plug Housing

APPROVED BY	SCALE	UNIT	TOLERANCE	LTR	REVISION RECORD	DATE	LTR	REVISION RECORD	DATE
林宗		mm	.0 ±0.3	ECR	RoHS Compliant	06/04/01			
CHECKED BY	PROJ	VER NO.	.00 ±0.2	ECR	200905-001	09/05/07			
		a2	.000 ±0.1	ECR	200908-005	09/08/14			
DRAWN BY	DATE	SIZE	ALL ±				CUSTOMER		
黃科源	2009/08/14	A4	ANGLE				Conforms to The RoHS Instruction		
			0° ±						
			-0° ±						

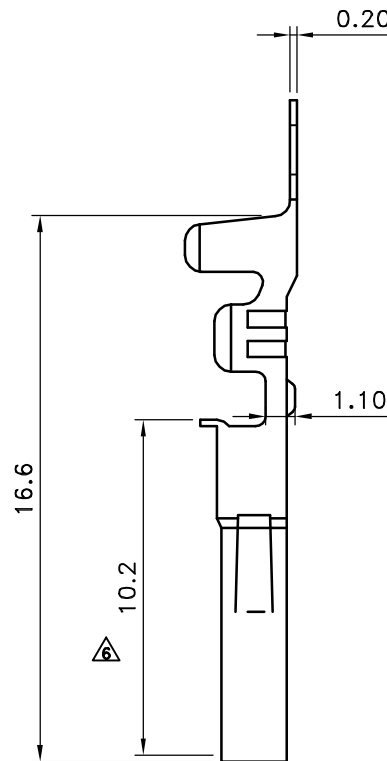
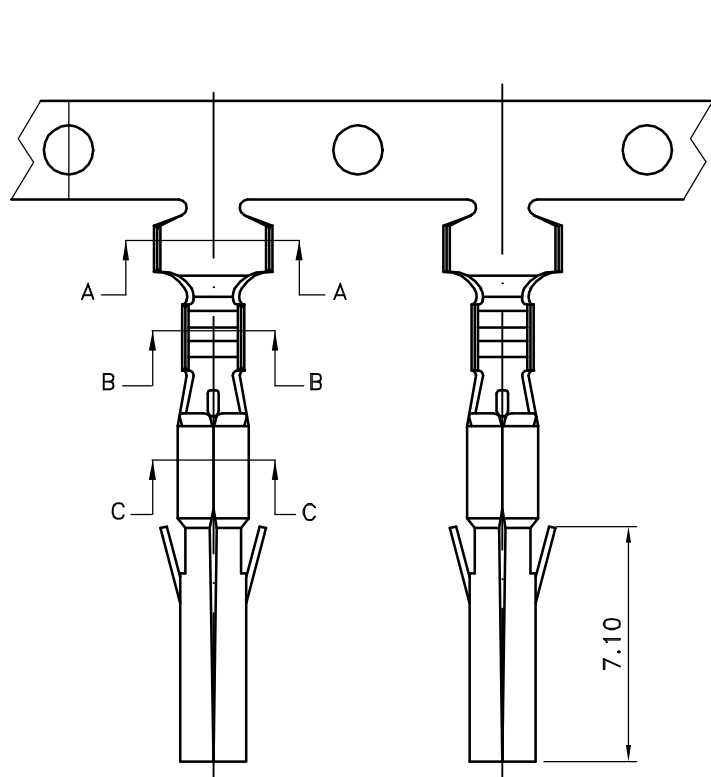

- **SPECIFICATIONS**
- Voltage Rating : 250 V AC/DC
 - Current Rating : 6 A AC/DC
 - Withstanding Voltage : 1,500V AC/minute
 - Insulation Resistance : 1,000M Ω min
 - △ Temperature Range : - 25 °C to + 105 °C
 - Contact Resistance : 20m Ω max

- **TERMINAL**
- Part No. : JS-24158BS-2
 - Applicable Wires : AWG # 18 - 24
 - Material : Brass
 - Finish : Tin Plated
 - Thickness : 0.2 mm
 - Q' ty : 7,000 pcs./Reel

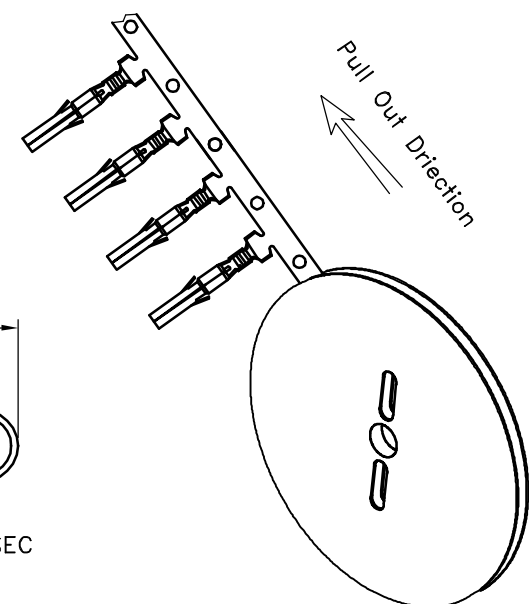
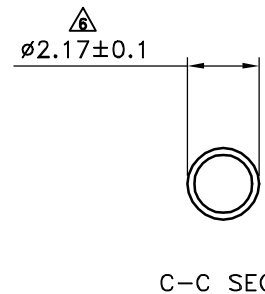
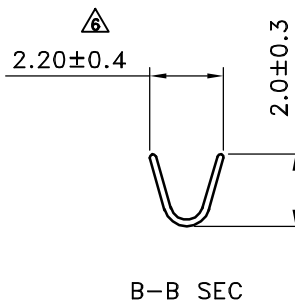
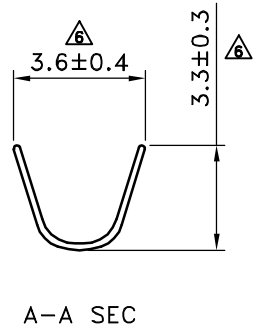
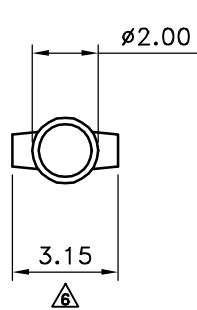

CS 喬訊電子工業股份有限公司
CHYAO SHIUNN
ELECTRONIC INDUSTRIAL LTD.

PART NO JS-24158BS-2
∅1.58mm Power Connectors Terminal

APPROVED BY	SCALE	UNIT	TOLERANCE	LTR	REVISION RECORD	NAME	DATE	LTR	REVISION RECORD	NAME	DATE
Tom Shih		mm	.0 ±0.30	△	ECR 200609-002	陳文裕	2006/09/15	△			
CHECKED BY	PROJ	VER NO.	.00 ±0.20	△	ECR 200612-002	林文彬	2006/12/20	△			
Erin Chou		a6	.000 ±0.10	△	ECR 200905-004	黃科源	2009/05/07	△			
DRAWN BY	DATE	SIZE	ANGLE		增加端子捲繞方向圖		吳弘文	2014/10/23	CUSTOMER		
Eddie	2023/02/22	A4	0°	±1°	△	修定規格	吳弘文	2014/12/31			
			.0°	±	△	修正尺寸	Eddie	2023/02/22			
SHEET			1/1	△	Conforms to The RoHS Instruction						