

A4

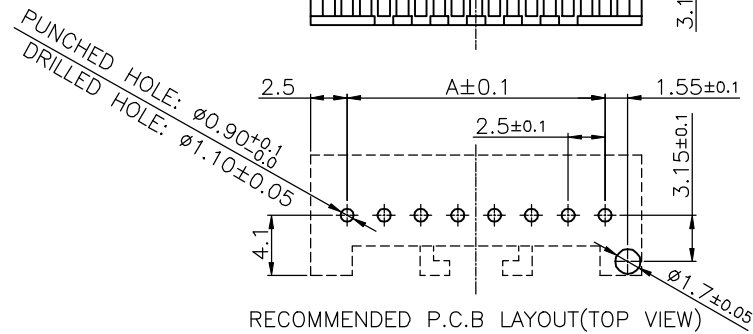
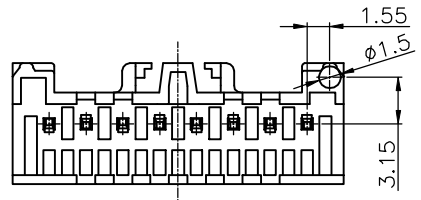
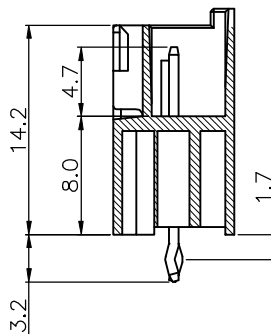
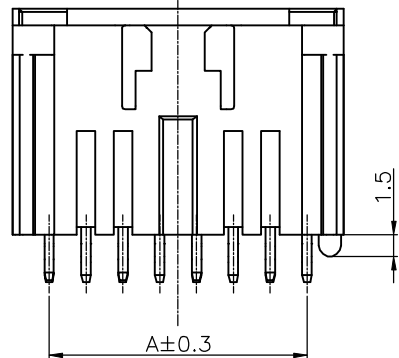
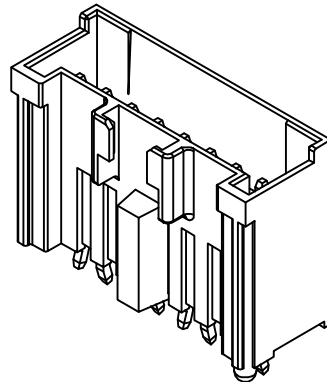
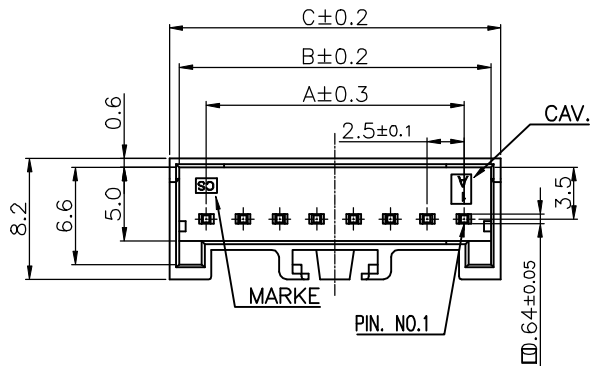

REV.	ECN NO.	REVISIONS	REV.DRAWN	DATE
A		初版发行	sunquan	2012/05/22
B		修改实物与图纸一致	YangSong	2018/12/20

- NOTES:
- MATERIAL:
Base: Nylon Glass Filled, UL94V-0
Contact: Brass, Tin Plated
 - PART NO.
JS-2501-XXK-XXXX-XX
Poles: 02~13
Blank: PA66+15%GF
D5: PA66+15%GF(NH)
Blank: Normal
NH: Halogen Free
Blank: Nature
RD: Red
 - MATING WITH: JS-2502-XX
 - APPLICABLE PCB THICKNESS: 1.6mm
 - HALOGEN FREE PRODUCT IDENTIFICATION LOGO ON THE PACKING
 - PACKING : Bag

Poles	A	B	C
02	2.50	6.20	7.50
03	5.00	8.70	10.00
04	7.50	11.20	12.50
05	10.00	13.70	15.00
06	12.50	16.20	17.50
07	15.00	18.70	20.00
08	17.50	21.20	22.50
09	20.00	23.70	25.00
10	22.50	26.20	27.50
11	25.00	28.70	30.00
12	27.50	31.20	32.50
13	30.00	33.70	35.00

Circuit No.	1	2	3	4	5	6	7	8	9	10	11	12	13
TYPE OF KINK FORM	A	B	A	B	A	B	A	B	A	B	A	B	A

X. ± 0.40	X.* ± 5.0'	UNITS: mm	NAME(INTENDED USE):	
.X ± 0.30	.X* ± 2.0'	MATERIAL:	CUSTOMER	
.XX ± 0.20	.XX* ± 1.0'	SEE NOTE	PART NO.(INTENDED USE):	TITLE:
.XXX ± 0.10	.XXX* ± ---	FINISH:	JS-2501-XX	2.5MM PITCH SIGNAL DBL-LOCK POST HEADER CONN. ASS'Y
<small>THESE DRAWINGS AND SPECIFICATIONS ARE THE PROPERTY OF CHYAO SHUINN ELECTRONIC CO., LTD. AND SHALL NOT BE REPRODUCED, COPIED OR USED IN ANY MANNER WITHOUT THE PRIOR WRITTEN CONSENT OF CHYAO SHUINN ELECTRONIC CO., LTD.</small>		Q'TY:	APPD:	DWG NO.:
SEE NOTE	CHKD:	DR:	sunquan 2012/05/22	010-0128-2501-XX
SEE NOTE	SCALE	SHEET	REV.	
	2:1	1/2	B	

符合环境管理物质



A4

REV.	ECN NO.	REVISIONS	REV.DRAWN	DATE
A	/	初版发行	sunquan	2012/05/22
B	/	修改实物与图纸一致	YangSong	2018/12/20

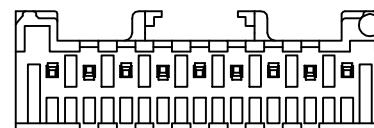
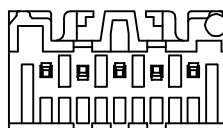
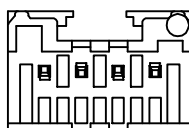
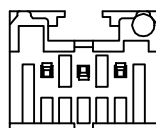
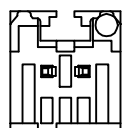
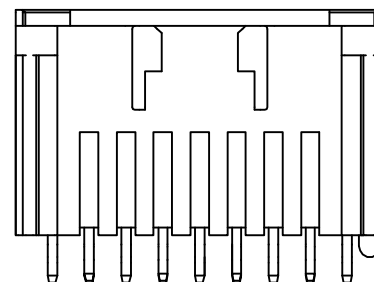
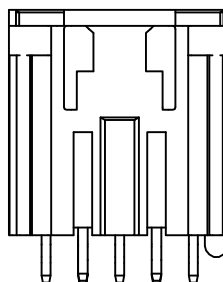
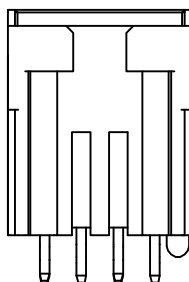
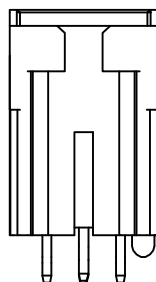
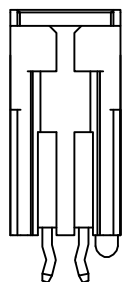
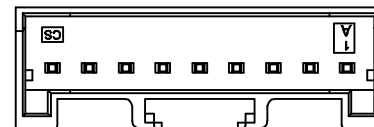
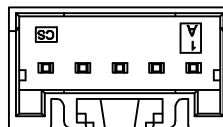
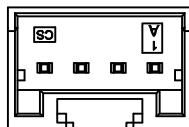
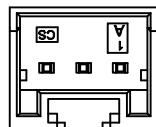
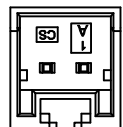

02 Pin

03 Pin

04 Pin

05~08 Pin

09~13 Pin

X. ± 0.40	X.* ± 5.0°	UNITS: mm	NAME(INTENDED USE):							
.X ± 0.30	.X* ± 2.0°	MATERIAL:	CUSTOMER							
.XX ± 0.20	.XX* ± 1.0°	SEE NOTE	PART NO.(INTENDED USE):	TITLE:						
.XXX ± 0.10	.XXX* ± ---	FINISH:	JS-2501-XX	2.5MM PITCH SIGNAL DBL-LOCK POST HEADER CONN. ASS'Y						
<small>THESE DRAWINGS AND SPECIFICATIONS ARE THE PROPERTY OF CHYAO SHUINN ELECTRONIC CO., LTD. AND SHALL NOT BE REPRODUCED, COPIED OR USED IN ANY MANNER WITHOUT THE PRIOR WRITTEN CONSENT OF CHYAO SHUINN ELECTRONIC CO., LTD.</small>		SEE NOTE	APPD:	DWG NO.:						
		Q'TY:	CHKD:	010-0128-2501-XX						
		SEE NOTE	DR:	<table border="1"> <thead> <tr> <th>SCALE</th> <th>SHEET</th> <th>REV.</th> </tr> </thead> <tbody> <tr> <td>2:1</td> <td>2/2</td> <td>B</td> </tr> </tbody> </table>	SCALE	SHEET	REV.	2:1	2/2	B
SCALE	SHEET	REV.								
2:1	2/2	B								
			sunquan 2012/05/22							

符合环境管理物质

