

2P-10P B±0.15  
 11P-20P B±0.25  
 21P-40P B±0.35

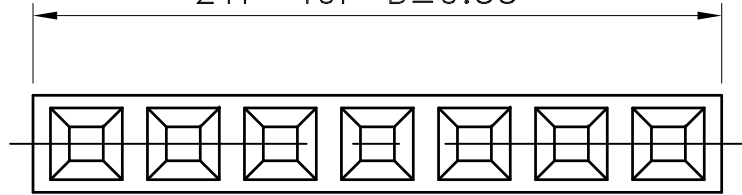

2P-10P A±0.1  
 11P-20P A±0.2  
 21P-40P A±0.3

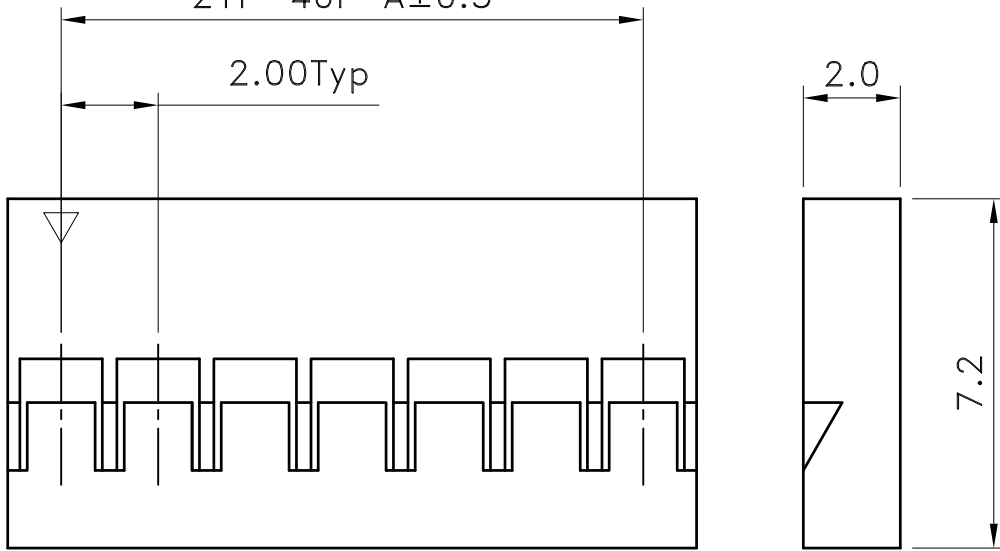

■ SPECIFICATIONS

- Voltage Rating : 125V AC/DC
- Current Rating : 2A AC/DC
- Withstanding Voltage : 1000V AC/minute
- Insulation Resistance : 1000MΩ min.
- Temperature Range : - 40°C to + 105°C
- Contact Resistance : 20mΩ max

■ HOUSING

△ Part No. : JS-1163-XX (XX)

Code No : ① ②

① Poles : 2-40

② Base Material

Blank : Nylon 66 UL94V-2

△ V0 : Nylon 66 UL94V-0

• Material : Refer The Above Options

• Q' ty : 1000 pcs./Bag

Poles	Dimensions(mm)		Poles	Dimensions(mm)	
	A	B		A	B
2	2.00	4.20	22	42.00	44.20
3	4.00	6.20	23	44.00	46.20
4	6.00	8.20	24	46.00	48.20
5	8.00	10.20	25	48.00	50.20
6	10.00	12.20	26	50.00	52.20
7	12.00	14.20	27	52.00	54.20
8	14.00	16.20	28	54.00	56.20
9	16.00	18.20	29	56.00	58.20
10	18.00	20.20	30	58.00	60.20
11	20.00	22.20	31	60.00	62.20
12	22.00	24.20	32	62.00	64.20
13	24.00	26.20	33	64.00	66.20
14	26.00	28.20	34	66.00	68.20
15	28.00	30.20	35	68.00	70.20
16	30.00	32.20	36	70.00	72.20
17	32.00	34.20	37	72.00	74.20
18	34.00	36.20	38	74.00	76.20
19	36.00	38.20	39	76.00	78.20
20	38.00	40.20	40	78.00	80.20
21	40.00	42.20			

 喬訊電子工業股份有限公司  
**CHYAO SHIUNN**  
**ELECTRONIC INDUSTRIAL LTD.**

APPROVED BY	SCALE	UNIT	TOLERANCE	LTR	REVISION RECORD	NAME	DATE	LTR	REVISION RECORD	NAME	DATE
張育瑞		mm	.0 ±0.30	△	ECR RoHS compliant	余秀麗	2006/04/01	△			
CHECKED BY	PROJ	VER NO.	.00 ±0.20	△	ECR 200808-015	黃科源	2008/08/26	△			
黃科源		a4	.000 ±0.10	△	ECR 200811-017	黃科源	2008/11/20	△			
DRAWN BY	DATE	SIZE	ANGLE		增加V0料選項	吳弘文	2014/06/25		CUSTOMER		
吳弘文	2014/06/26	A4	0° ±1°	△					Conforms to The RoHS Instruction		
			.0° ±	△							
			SHEET 1/1	△							

**PART NO JS-1163-XX(XX)**  
**2.00mm Center Mini Latch Housing**

4P-20P A±0.15  
 22P-36P A±0.25  
 38P-80P A±0.35

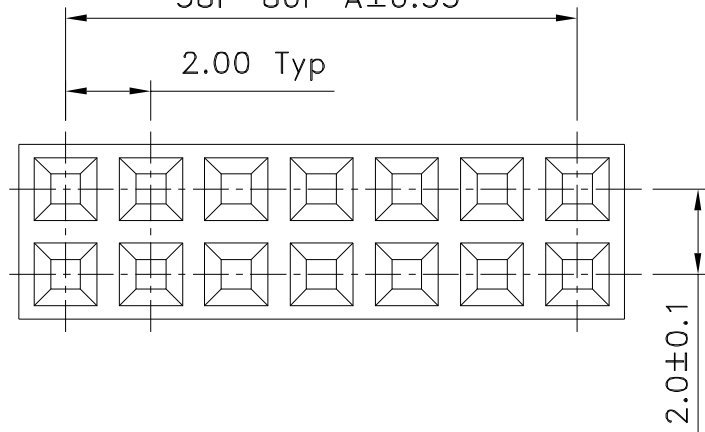

4P-20P B±0.2  
 22P-36P B±0.3  
 38P-80P B±0.4

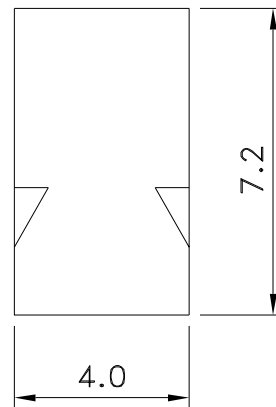
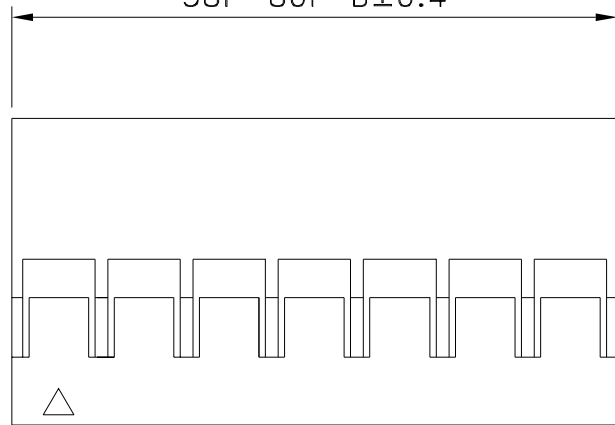

■ SPECIFICATIONS

- Voltage Rating : 125V AC/DC
- Current Rating : 2A AC/DC
- Withstanding Voltage : 1000V AC/minute
- Insulation Resistance : 1000M Ω min
- Temperature Range : - 40°C to +105°C
- Contact Resistance : 20m Ω max

■ HOUSING

- Part No. : JS-1164-XXx2
- Poles : 2x2 - 40x2
- Material : Nylon 66 UL94V-2
- Q' ty : 1,000 pcs./Bag

Poles	Part No.	Dimensions(mm)		Poles	Part No.	Dimensions(mm)	
		A	B			A	B
4	JS-1164-02x2	2.00	4.20	44	JS-1164-22x2	42.00	44.20
6	JS-1164-03x2	4.00	6.20	46	JS-1164-23x2	44.00	46.20
8	JS-1164-04x2	6.00	8.20	48	JS-1164-24x2	46.00	48.20
10	JS-1164-05x2	8.00	10.20	50	JS-1164-25x2	48.00	50.20
12	JS-1164-06x2	10.00	12.20	52	JS-1164-26x2	50.00	52.20
14	JS-1164-07x2	12.00	14.20	54	JS-1164-27x2	52.00	54.20
16	JS-1164-08x2	14.00	16.20	56	JS-1164-28x2	54.00	56.20
18	JS-1164-09x2	16.00	18.20	58	JS-1164-29x2	56.00	58.20
20	JS-1164-10x2	18.00	20.20	60	JS-1164-30x2	58.00	60.20
22	JS-1164-11x2	20.00	22.20	62	JS-1164-31x2	60.00	62.20
24	JS-1164-12x2	22.00	24.20	64	JS-1164-32x2	62.00	64.20
26	JS-1164-13x2	24.00	26.20	66	JS-1164-33x2	64.00	66.20
28	JS-1164-14x2	26.00	28.20	68	JS-1164-34x2	66.00	68.20
30	JS-1164-15x2	28.00	30.20	70	JS-1164-35x2	68.00	70.20
32	JS-1164-16x2	30.00	32.20	72	JS-1164-36x2	70.00	72.20
34	JS-1164-17x2	32.00	34.20	74	JS-1164-37x2	72.00	74.20
36	JS-1164-18x2	34.00	36.20	76	JS-1164-38x2	74.00	76.20
38	JS-1164-19x2	36.00	38.20	78	JS-1164-39x2	76.00	78.20
40	JS-1164-20x2	38.00	40.20	80	JS-1164-40x2	78.00	80.20
42	JS-1164-21x2	40.00	42.20				



喬訊電子工業股份有限公司  
 CHYAO SHIUNN  
 ELECTRONIC INDUSTRIAL LTD.

APPROVED BY	SCALE	UNIT	TOLERANCE	LTR	REVISION RECORD	DATE	LTR	REVISION RECORD	DATE
林宗		mm	.0 ±0.3	ECR	RoHS compliant	06/04/01			
CHECKED BY	PROJ	VER NO.	.00 ±0.2	ECR	200808-015	08/08/26			
		a3	.000 ±0.1	ECR	200811-017	08/11/20			
DRAWN BY	DATE	SIZE	ALL ±				CUSTOMER		
黃科源	2008/11/20	A4	ANGLE				Conforms to The RoHS Instruction		
			0° ±						
			.0° ±						

PART NO JS-1164-XXx2  
 2.00mm Center Mini Latch Housing

8P-20P A±0.15  
22P-36P A±0.25  
38P-80P A±0.35

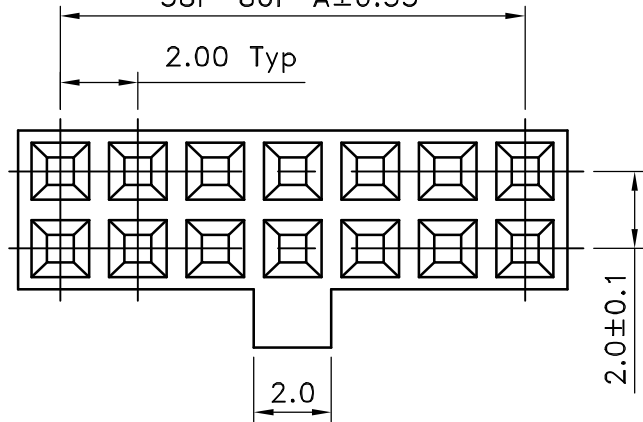

8P-20P B±0.2  
22P-36P B±0.3  
38P-80P B±0.4

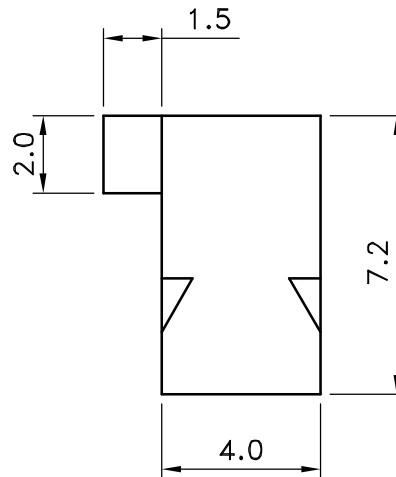
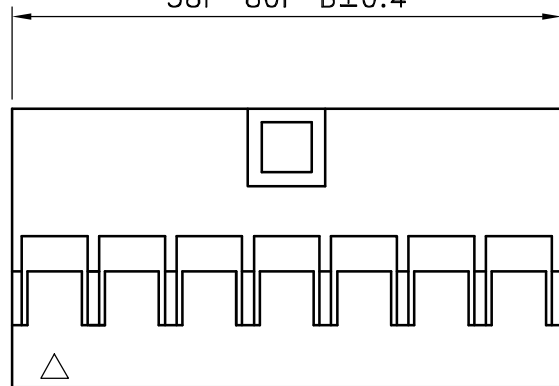

### ■ SPECIFICATIONS

- Voltage Rating : 250V AC/DC
- Current Rating : 1A AC/DC
- Withstanding Voltage : 1000V AC/minute
- Insulation Resistance : 1000MΩ min
- Temperature Range : - 25°C to + 85°C
- Contact Resistance : 20mΩ max

### ■ HOUSING

- Part No. : JS-1164B-XXx2
- △ • Poles : 4x2 - 40x2
- Material : Nylon 66 UL94V-2
- Q' ty : 1,000 pcs./Bag

Poles	Dimensions(mm)		Poles	Dimensions(mm)	
	A	B		A	B
4x2	6.00	8.20	23x2	44.00	46.20
5x2	8.00	10.20	24x2	46.00	48.20
6x2	10.00	12.20	25x2	48.00	50.20
7x2	12.00	14.20	26x2	50.00	52.20
8x2	14.00	16.20	27x2	52.00	54.20
9x2	16.00	18.20	28x2	54.00	56.20
10x2	18.00	20.20	29x2	56.00	58.20
11x2	20.00	22.20	30x2	58.00	60.20
12x2	22.00	24.20	31x2	60.00	62.20
13x2	24.00	26.20	32x2	62.00	64.20
14x2	26.00	28.20	33x2	64.00	66.20
15x2	28.00	30.20	34x2	66.00	68.20
16x2	30.00	32.20	35x2	68.00	70.20
17x2	32.00	34.20	36x2	70.00	72.20
18x2	34.00	36.20	37x2	72.00	74.20
19x2	36.00	38.20	38x2	74.00	76.20
20x2	38.00	40.20	39x2	76.00	78.20
21x2	40.00	42.20	40x2	78.00	80.20
22x2	42.00	44.20			



喬訊電子工業股份有限公司  
CHYAO SHIUNN  
ELECTRONIC INDUSTRIAL LTD.

APPROVED BY	SCALE	UNIT	TOLERANCE	LTR	REVISION RECORD	NAME	DATE	LTR	REVISION RECORD	NAME	DATE
Tom Shih		mm	.0 ±0.30	△	RoHS compliant	黃科源	2006/04/01	△			
CHECKED BY	PROJ	VER NO.	.00 ±0.20	△	200808-015	黃科源	2008/08/26	△			
Erin Chou		a4	.000 ±0.10	△	200811-017	黃科源	2008/11/20	△			
DRAWN BY	DATE	SIZE	ANGLE		更新圖框·更新Poles	Eddie	2022/10/21		CUSTOMER		
Eddie	2022/10/21	A4	0° ±1°	△					Conforms to The RoHS Instruction		
			.0° ±	△							
			SHEET	1/1	△						

PART NO JS-1164B-XXx2  
2.00mm Center Mini Latch Housing

4P-20P A±0.15  
 22P-36P A±0.25  
 38P-80P A±0.35

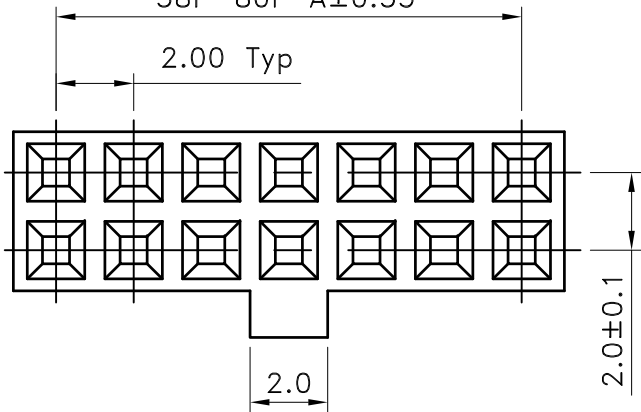

4P-20P B±0.2  
 22P-36P B±0.3  
 38P-80P B±0.4

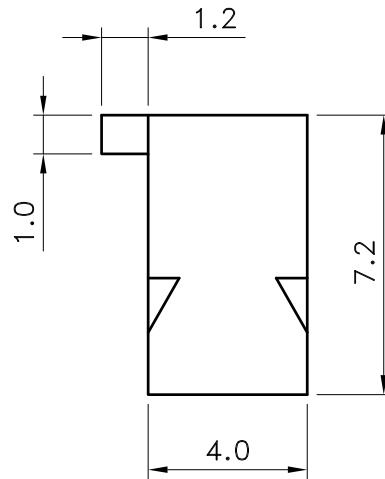
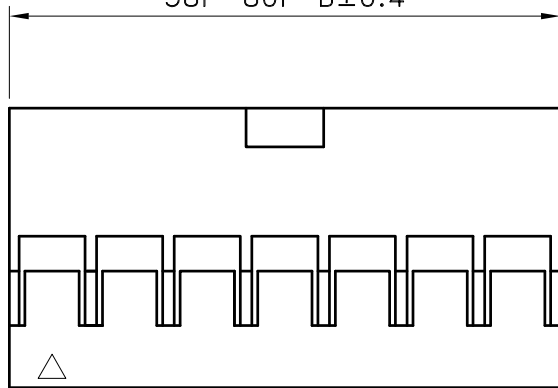

■ SPECIFICATIONS

- Voltage Rating : 250V AC/DC
- Current Rating : 1A AC/DC
- Withstanding Voltage : 1000V AC/minute
- Insulation Resistance : 1000MΩ min
- Temperature Range : - 25°C to + 85°C
- Contact Resistance : 20mΩ max

■ HOUSING

- Part No. : JS-1164BN-XXx2
- Poles : 2x2 - 40x2
- Material : Nylon 66 UL94V-2
- Q' ty : 1,000 pcs./Bag

Poles	Part No.	Dimensions(mm)		Poles	Part No.	Dimensions(mm)	
		A	B			A	B
4	JS-1164BN-02x2	2.00	4.20	44	JS-1164BN-22x2	42.00	44.20
6	JS-1164BN-03x2	4.00	6.20	46	JS-1164BN-23x2	44.00	46.20
8	JS-1164BN-04x2	6.00	8.20	48	JS-1164BN-24x2	46.00	48.20
10	JS-1164BN-05x2	8.00	10.20	50	JS-1164BN-25x2	48.00	50.20
12	JS-1164BN-06x2	10.00	12.20	52	JS-1164BN-26x2	50.00	52.20
14	JS-1164BN-07x2	12.00	14.20	54	JS-1164BN-27x2	52.00	54.20
16	JS-1164BN-08x2	14.00	16.20	56	JS-1164BN-28x2	54.00	56.20
18	JS-1164BN-09x2	16.00	18.20	58	JS-1164BN-29x2	56.00	58.20
20	JS-1164BN-10x2	18.00	20.20	60	JS-1164BN-30x2	58.00	60.20
22	JS-1164BN-11x2	20.00	22.20	62	JS-1164BN-31x2	60.00	62.20
24	JS-1164BN-12x2	22.00	24.20	64	JS-1164BN-32x2	62.00	64.20
26	JS-1164BN-13x2	24.00	26.20	66	JS-1164BN-33x2	64.00	66.20
28	JS-1164BN-14x2	26.00	28.20	68	JS-1164BN-34x2	66.00	68.20
30	JS-1164BN-15x2	28.00	30.20	70	JS-1164BN-35x2	68.00	70.20
32	JS-1164BN-16x2	30.00	32.20	72	JS-1164BN-36x2	70.00	72.20
34	JS-1164BN-17x2	32.00	34.20	74	JS-1164BN-37x2	72.00	74.20
36	JS-1164BN-18x2	34.00	36.20	76	JS-1164BN-38x2	74.00	76.20
38	JS-1164BN-19x2	36.00	38.20	78	JS-1164BN-39x2	76.00	78.20
40	JS-1164BN-20x2	38.00	40.20	80	JS-1164BN-40x2	78.00	80.20
42	JS-1164BN-21x2	40.00	42.20				



喬訊電子工業股份有限公司  
 CHYAO SHIUNN  
 ELECTRONIC INDUSTRIAL LTD.

APPROVED BY	SCALE	UNIT	TOLERANCE	LTR	REVISION RECORD	DATE	LTR	REVISION RECORD	DATE
林宗		mm	.0 ±0.3	ECR	RoHS compliant	06/04/01			
CHECKED BY	PROJ	VER NO.	.00 ±0.2	ECR	200808-015	08/08/26			
		a3	.000 ±0.1	ECR	200811-017	08/11/20			
DRAWN BY	DATE	SIZE	ALL ±				CUSTOMER		
黃科源	2008/08/22	A4	ANGLE				Conforms to The RoHS Instruction		
			0° ±						
			.0° ±						

PART NO JS-1164BN-XXx2

2.00mm Center Mini Latch Housing

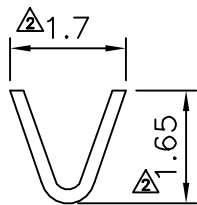
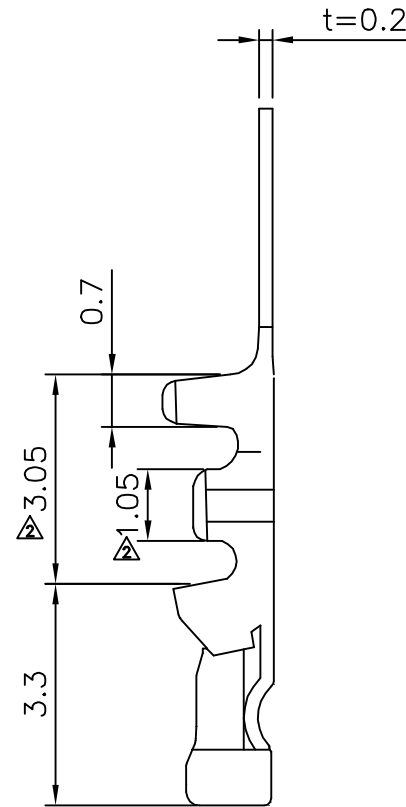
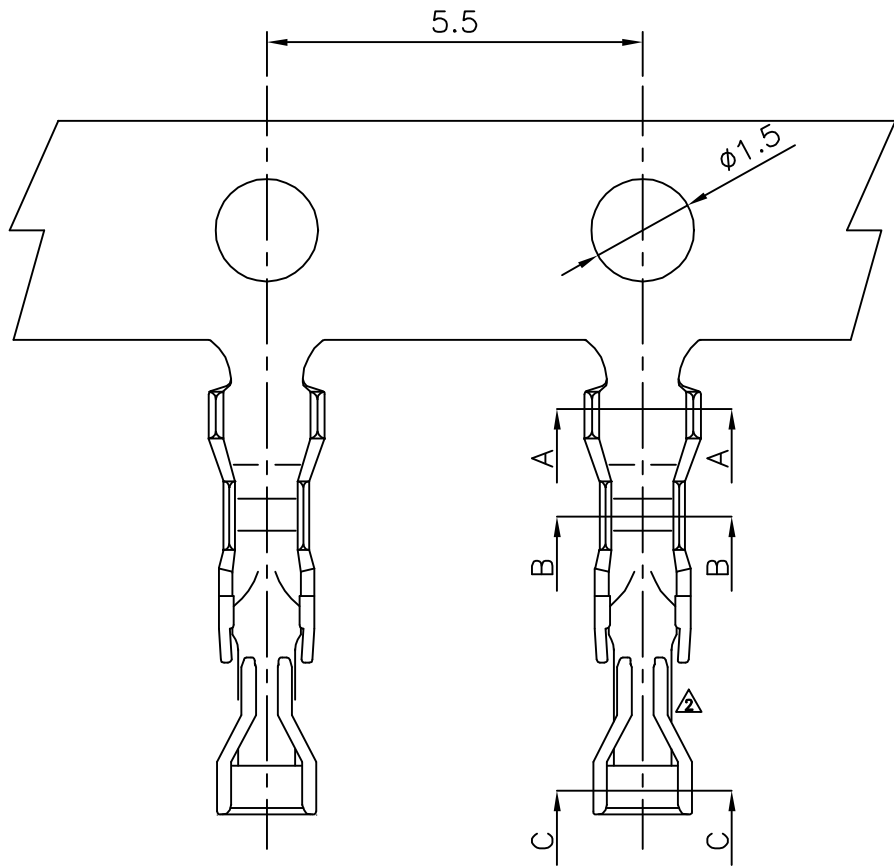

Section A-A

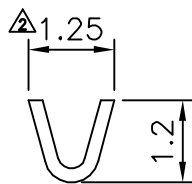

Section B-B

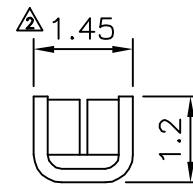

Section C-C

- **SPECIFICATIONS**
- Voltage Rating : 125 V AC/DC
  - △ • Current Rating : 1A AC/DC
  - Withstanding Voltage : 1,000V AC/minute
  - Insulation Resistance : 1,000M Ω min
  - Temperature Range : - 40°C to + 105°C
  - Contact Resistance : 20m Ω max
- **TERMINAL**
- △ • Part No. : JS-1163-T
  - Applicable Wires : AWG# 26 - 30
  - Material : Material : Phos. Bronze
  - Finish : Gold Plated
  - Thickness : 0.2mm
  - Q' ty : 20,000 pcs./Reel



喬訊電子工業股份有限公司  
CHYAO SHIUNN  
ELECTRONIC INDUSTRIAL LTD.

APPROVED BY	SCALE	UNIT	TOLERANCE	LTR	REVISION RECORD	NAME	DATE	LTR	REVISION RECORD	NAME	DATE
Tom Shih		mm	.0 ±0.30	△	刪除GP料號，依規格書修改電流	張逸維	2013/01/02	△			
CHECKED BY	PROJ	VER NO.	.00 ±0.20	△	修改端子外型及部分尺寸	Tom Lee	2018/04/11	△			
Erin Chou	☉	a2	.000 ±0.10	△				△			
DRAWN BY	DATE	SIZE	ANGLE	△					CUSTOMER		
Tom Lee	2018/04/11	A4	0° ±1°	△					Conforms to The RoHS Instruction		
			.0° ±	△							
			SHEET 1/1	△							

PART NO JS-1163-T

2.00mm Center Mini Latch Terminal