

REV	ECN.NO.	REVISIONS	REV.DRAWN	DATE
H		增加DO材质	sunquan	10-02/04
I		删除尺寸D列	sunquan	10-07/28
J		增加尺寸标注	sunquan	10-08/16
K	ECN 14010	凸点没变	Zuochao	2014.03.27

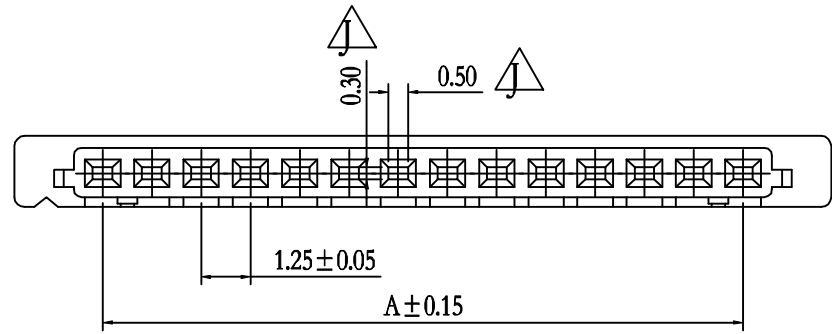

**SPECIFICATIONS**

- . Voltage Rating : 125V AC/DC
- . Current Rating : 1A AC/DC
- . Withstanding Voltage : 250V AC/minute
- . Insulation Resistance ; 100MΩ min
- . Temperature Range : -40° C to +85° C
- . Contact Resistance : 20mΩ max

**NOTES:**

1. Material: Thermoplastic, UL94V-0
2. Q'ty : 1,000 Pcs/Bag
3. Part No.

JS-1258-XX-XXXX-XX

- Poles: 2~30P
- Blank: PBT
- DO: PA66(NH)
- Blank: Normal
- NH: Halogen Free
- Blank: Normal
- BK:Black

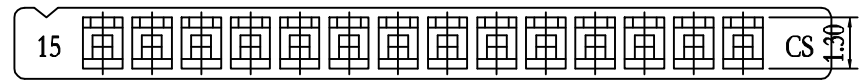
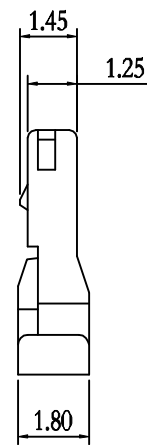
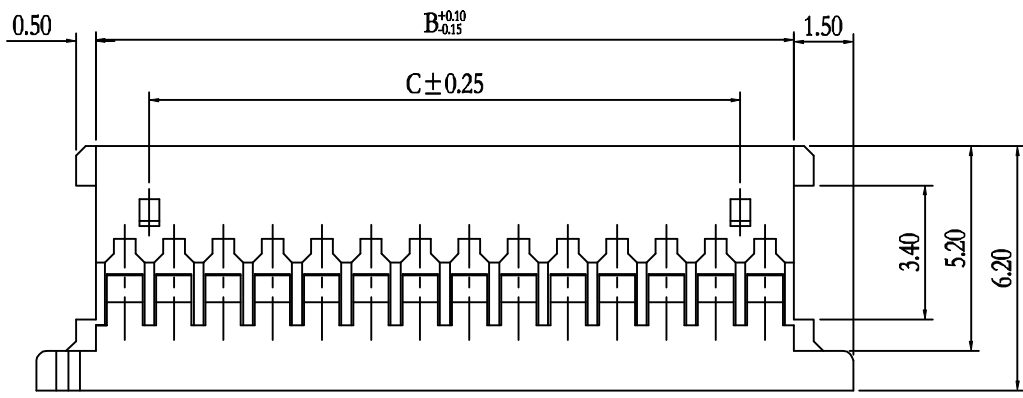

Poles	Dimensions			Poles	Dimensions		
	A	B	C		A	B	C
				16	18.75	20.22	17.50
02	1.25	2.72	-	17	20.00	21.47	18.75
03	2.50	3.97	-	18	21.25	22.72	20.00
04	3.75	5.22	2.50	19	22.50	23.97	21.25
05	5.00	6.47	3.75	20	23.75	25.22	22.50
06	6.25	7.72	5.00	21	25.00	26.47	22.50
07	7.50	8.97	6.25	22	26.25	27.72	22.50
08	8.75	10.22	7.50	23	27.50	28.97	22.50
09	10.00	11.47	8.75	24	28.75	30.22	22.50
10	11.25	12.72	10.00	25	30.00	31.47	22.50
11	12.50	13.97	11.25	26	31.25	32.72	22.50
12	13.75	15.22	12.50	27	32.50	33.97	22.50
13	15.00	16.47	13.75	28	33.75	35.22	22.50
14	16.25	17.72	15.00	29	35.00	36.47	22.50
15	17.50	18.97	16.25	30	36.25	37.72	22.50

X.± 0.50	X'.± 5.0'	UNITS mm	NAME(INTENDED USE) <b>CUSTOMER</b>	CHYAO SHIUNN ELECTRONIC (SHANGHAI) CO.,LTD.
.X± 0.30	.X'± 2.0'			
.XX± 0.20	.XX'± 1.0'	FINISH	APPD:	DWG NO.:
.XXX± 0.10	.XXX'± 0.5'		Q'TY	CHKD:
THESE DRAWINGS AND SPECIFICATIONS ARE THE PROPERTY OF CHYAO SHIUNN ELECTRONIC CO., LTD. AND SHALL NOT BE REPRODUCED, COPIED OR USED IN ANY MANNER WITHOUT THE PRIOR WRITTEN CONSENT OF CHYAO SHIUNN ELECTRONIC CO., LTD.				DR: Asimo 2009/09/19
				2:1 1/1 K



符合环境管理物质

A4

REV.	ECN.NO	REVISIONS	REV.DRAWN	DATE
P	/	新增塑胶盖包装规格	YangSong	2016/08/24
Q	/	合并料号	Y.H.ZHANG	2018/2/08

**SPECIFICATION**  
 . Voltage Rating : 125V AC/DC  
 . Current Rating : 1A AC/DC  
 . Withstanding Voltage : 250V AC/Minute  
 . Insulation Resistance : 100M Ω Min.  
 . Temperature Range : -25°C~+85°C  
 . Contact Resistance : 20m Ω Max.

**NOTES:**  
 1. Material: Base: High Temp Plastic, UL94V-0  
 Contact: Brass, Tin Plated/Gold plated  
 Ear: Brass, Tin plated  
 2. Color: Nature of material/Black  
 3. Q'ty : 2,000 Pcs/Reel  
 4. Part No1.  
 JS-1259-XXXXXX-XX-XX-X-X

Poles: 2~30  
 Blank: Tin plated  
 M: Matte Sn  
 G0: Gold Plated  
 Tin Plated(EAR)  
 BLANK: Paper plate  
 S: plastic plate  
 Blank: Transparent Packing  
 B: Black Packing  
 Blank: Normal  
 NH: Halogen Free  
 Blank: Nature  
 BK: Black  
 Blank: No adhibit MYLAR  
 ML: Adhibit MYLAR

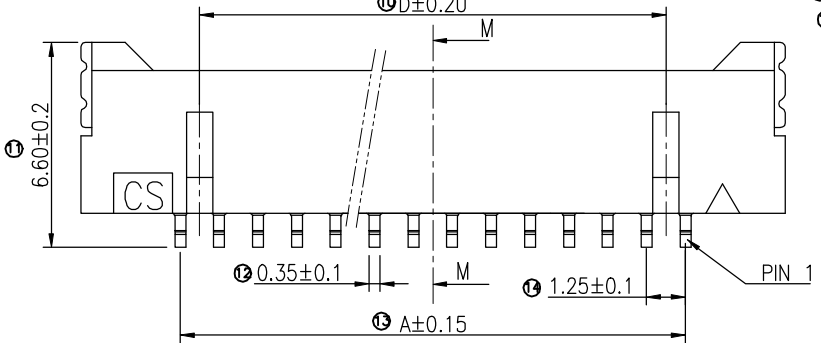
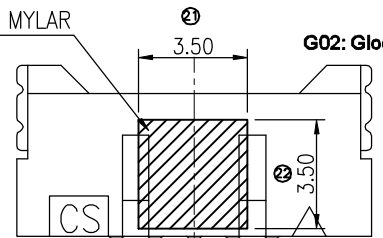
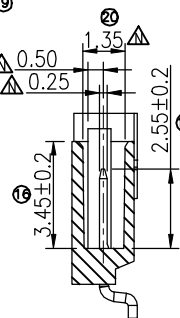
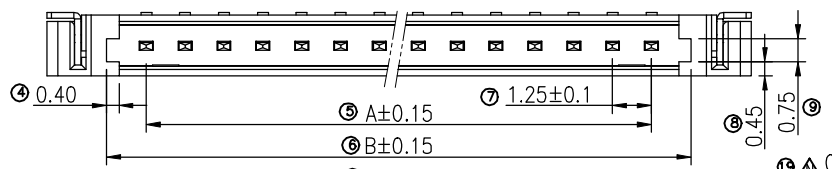
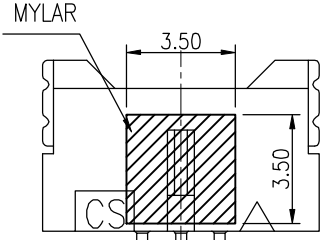
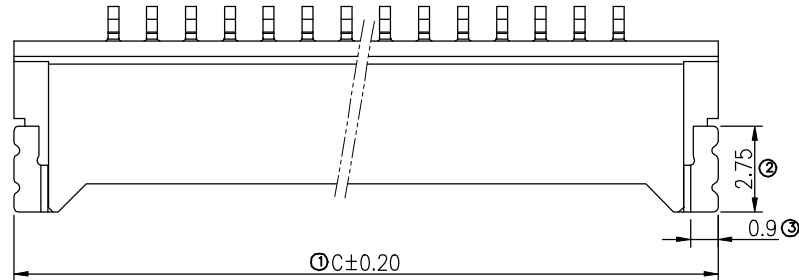

Poles	Dimensions(mm)				Poles	Dimensions(mm)			
	A	B	C	D		A	B	C	D
02	1.25	3.80	7.65	--	17	20.00	22.55	16.40	18.75
03	2.50	5.05	8.90	--	18	21.25	23.80	27.65	20.00
04	3.75	6.30	10.15	2.50	19	22.50	25.05	28.90	21.25
05	5.00	7.55	11.40	3.75	20	23.75	26.30	30.15	22.50
06	6.25	8.80	12.65	5.00	21	25.00	27.55	31.40	22.50
07	7.50	10.05	13.90	6.25	22	26.25	28.80	32.65	22.50
08	8.75	11.30	15.15	7.50	23	27.50	30.05	33.90	22.50
09	10.00	12.55	16.40	8.75	24	28.75	31.30	35.15	22.50
10	11.25	13.80	17.65	10.00	25	30.00	32.55	36.40	22.50
11	12.50	15.05	18.90	11.25	26	31.25	33.80	37.65	22.50
12	13.75	16.30	20.15	12.50	27	32.50	35.05	38.90	22.50
13	15.00	17.55	21.40	13.75	28	33.75	36.30	40.15	22.50
14	16.25	18.80	22.65	15.00	29	35.00	37.55	41.40	22.50
15	17.50	20.05	23.90	16.25	30	36.25	38.80	42.65	22.50
16	18.75	21.30	25.15	17.50					

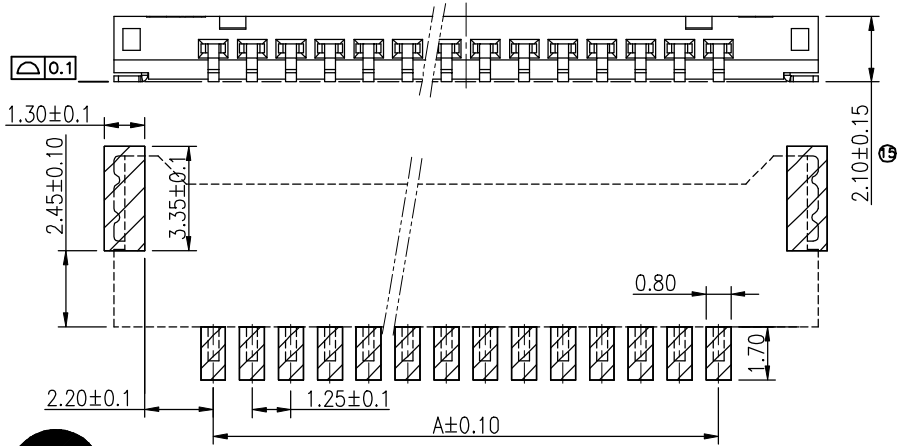

Recommended PCB Layout

X. ±0.40	X.* ±5.0°	UNITS mm	NAME(INTENDED USE)	乔讯电子(上海)有限公司 CHYAO SHUINN ELECTRONICS(SHANGHAI)CO.,LTD.
.X ±0.30	.X* ±2.0°	MAT'S	CUSTOMER	
.XX ±0.20	.XX* ±1.0°	SEE NOTE	PART NO.(INTENDED USE)	TITLE:
.XXX ±0.10	--- --	FINISH	JS-1259-XX	1.25mm Crimp Style Connectors
THESE DRAWINGS AND SPECIFICATIONS ARE THE PROPERTY OF CHYAO SHUINN ELECTRONIC CO.,LTD. AND SHALL NOT BE REPRODUCED, COPIED OR USED IN ANY MANNER WITHOUT THE PRIOR WRITTEN CONSENT OF CHYAO SHUINN ELECTRONIC CO.,LTD.			APPV'D	DWG NO.
Q'TY			CHK'D	020-0095-1259-XX
---			DR': Asimo 2010-05-10	SCALE SHEET REV
				4 : 1 1/1 /

符合环境管理物质



REV	ECN.NO.	REVISIONS	REV.DRAWN	DATE
C		增加剖面标识	CARRY	08-01/18
D		增加镀层测点标识	hejihuai	09-02/16
E		增加尺寸标注	sunquan	10-08/16
F		增加电镀规格 (先冲后镀)	sunquan	11-02/17

### SPECIFICATIONS

- . Voltage Rating : 125V AC/DC
- . Current Rating : 1A AC/DC
- . Withstanding Voltage : 250V AC/minute
- . Insulation Resistance ; 100MΩ min
- . Temperature Range : -40°C to +85°C
- . Contact Resistance : 20mΩ max

### TERMINAL

. Part No Legend: JS-1258-TXX

- Tin Plated**
- 2: Sn>100u" Ni>30u"
  - 3: Sn>150u" Ni>50u"
  - △4: Sn>50u" Ni>10u"
- Gold Plated**
- G0: Au>0.8u" Ni>30u"
  - G1: Au>3u" Ni>30u"
  - G2: Au>5u" Ni>50u"
  - G3: Au>8u" Ni>50u"
  - G4: Au>15u" Ni>50u"

- . Applicable Wires :AWG#28-32
- . Material : Phos. Bronze
- . Finish : Tin/Gold Plated
- . Thickness : 0.15mm
- . Q'ty : 15,000pcs/Reel

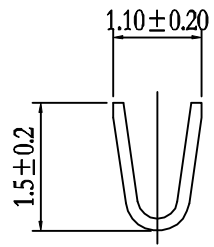
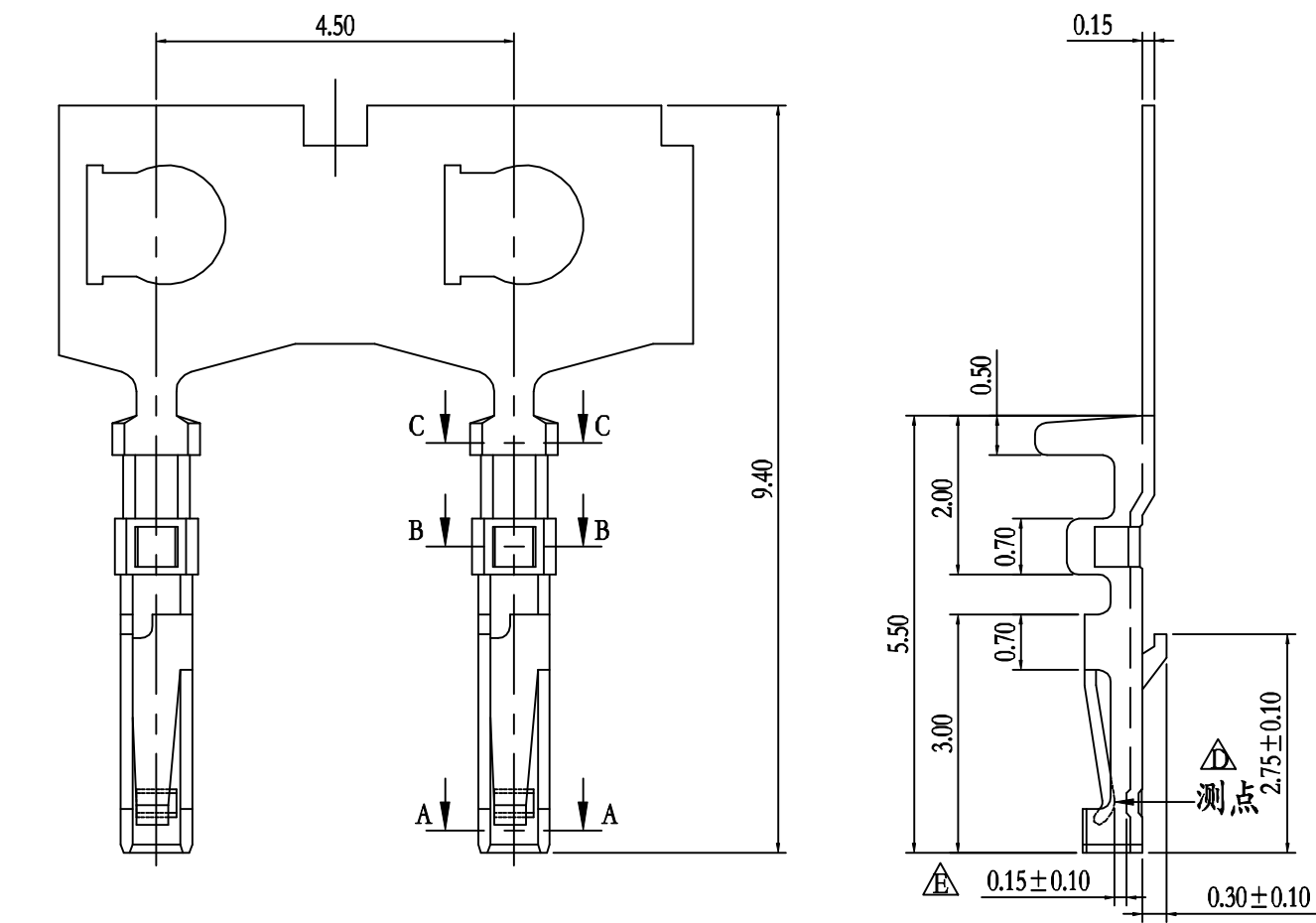

SECTION:C-C

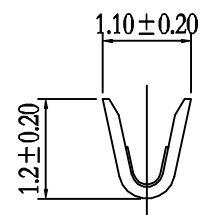

SECTION:B-B

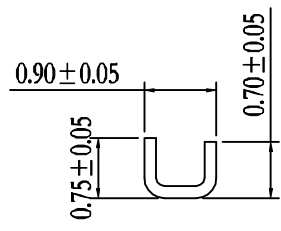

SECTION:A-A

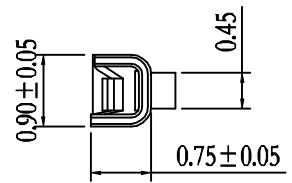

符合环境管理物质

X.± 0.50	X'.± 5.0'	UNITS	mm
.X± 0.30	.X'± 2.0'	MAT'L	
.XX± 0.20	.XX'± 1.0'	FINISH	
.XXX± 0.10	.XXX'± 0.5'		
THESE DRAWINGS AND SPECIFICATIONS ARE THE PROPERTY OF CHYAO SHUINN ELECTRONIC CO., LTD. AND SHALL NOT BE REPRODUCED, COPIED OR USED IN ANY MANNER WITHOUT THE PRIOR WRITTEN CONSENT OF CHYAO SHUINN ELECTRONIC CO., LTD.			
Q'TY			

NAME(INTENDED USE)		CUSTOMER	
PART NO.(INTENDED USE)		TITLE:	
APPD: liuzhiwen 11-02/17		DWG NO.:	
CHKD:		SCALE SHEET REV.	
DR: HEJIHUI 09-02/16		2:1 1/1 F	

**CHYAO SHUINN ELECTRONIC (SHANGHAI) CO.,LTD.**

**WIRE TO BOARD CONNECTOR**

020-0030-1258-T