

REV	ECN.NO.	REVISIONS	REV.DRAWN	DATE
D		增加2P, 3P视图	sunquan	12-11/29
E		尺寸列表补齐pin位	sunquan	13-05/09

SPECIFICATIONS

- . Voltage Rating : 100V AC/DC
- . Current Rating : 1A AC/DC
- . Withstanding Voltage : 500V AC/minute
- . Insulation Resistance : 500MΩ min
- . Temperature Range : -25°C to +85°C
- . Contact Resistance : 20mΩ max

HOUSING

- . Part No. : JS-1225-XXW-XX
- . Blank: beige
- . W: White
- . Blank: Normal
- . NH: Halogen free
- . Poles : 2~30
- . Material : Nylon 66 UL 94V-0
- . Q'ty : 1,000 pcs/Bag
- . Halogen free product identification LOGO on the packing

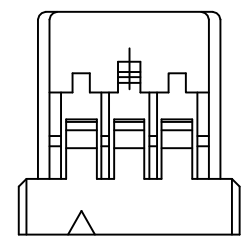
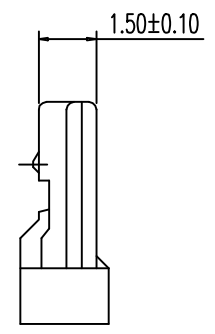
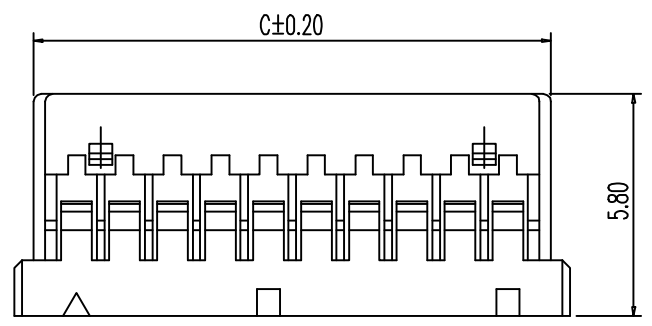
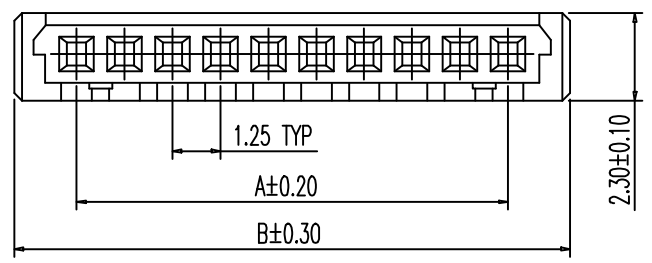

3P

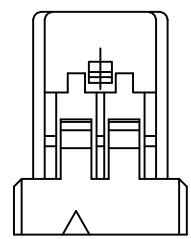

2P

Poles	DIMENSIONS			Poles	DIMENSIONS		
	A	B	C		A	B	C
02	1.25	4.50	3.50	17	20.00	23.25	22.25
03	2.50	5.75	4.75	18	21.25	24.50	23.50
04	3.75	7.00	6.00	19	22.50	25.75	24.75
05	5.00	8.25	7.25	20	23.75	27.00	26.00
06	6.25	9.50	8.50	21	25.00	28.25	27.25
07	7.50	10.75	9.75	22	26.25	29.50	28.50
08	8.75	12.00	11.00	23	27.50	30.75	29.75
09	10.00	13.25	12.25	24	28.75	32.00	31.00
10	11.25	14.50	13.50	25	30.00	33.25	32.25
11	12.50	15.75	14.75	26	31.25	34.50	33.50
12	13.75	17.00	16.00	27	32.50	35.75	34.75
13	15.00	18.25	17.25	28	33.75	37.00	36.00
14	16.25	19.50	18.50	29	35.00	38.25	37.25
15	17.50	20.75	19.75	30	36.25	39.50	38.50
16	18.75	22.00	21.00				

X.± 0.40	X²± 5.0'	UNITS	mm	NAME(INTENDED USE)		CHYAO SHUINN ELECTRONIC (SHANGHAI) CO.,LTD.
.X± 0.30	.X²± 2.0'			CUSTOMER		
.XX± 0.20	.XX²± 1.0'	MAT'L	PA66	PART NO.(INTENDED USE)		TITLE:
.XXX± 0.01	.XXX²± ---			JS-1225-XX		WIRE TO BOARD CONNECTORS
THESE DRAWINGS AND SPECIFICATIONS ARE THE PROPERTY OF CHYAO SHUINN ELECTRONIC CO., LTD. AND SHALL NOT BE REPRODUCED, COPIED OR USED IN ANY MANNER WITHOUT THE PRIOR WRITTEN CONSENT OF CHYAO SHUINN ELECTRONIC CO., LTD.				APPD:	CHKD:	DWG NO.:
				Q'TY	DR:	07/05/05
				SCALE	SHEET	REV.
				10/1	1/1	/



符合环境管理物质

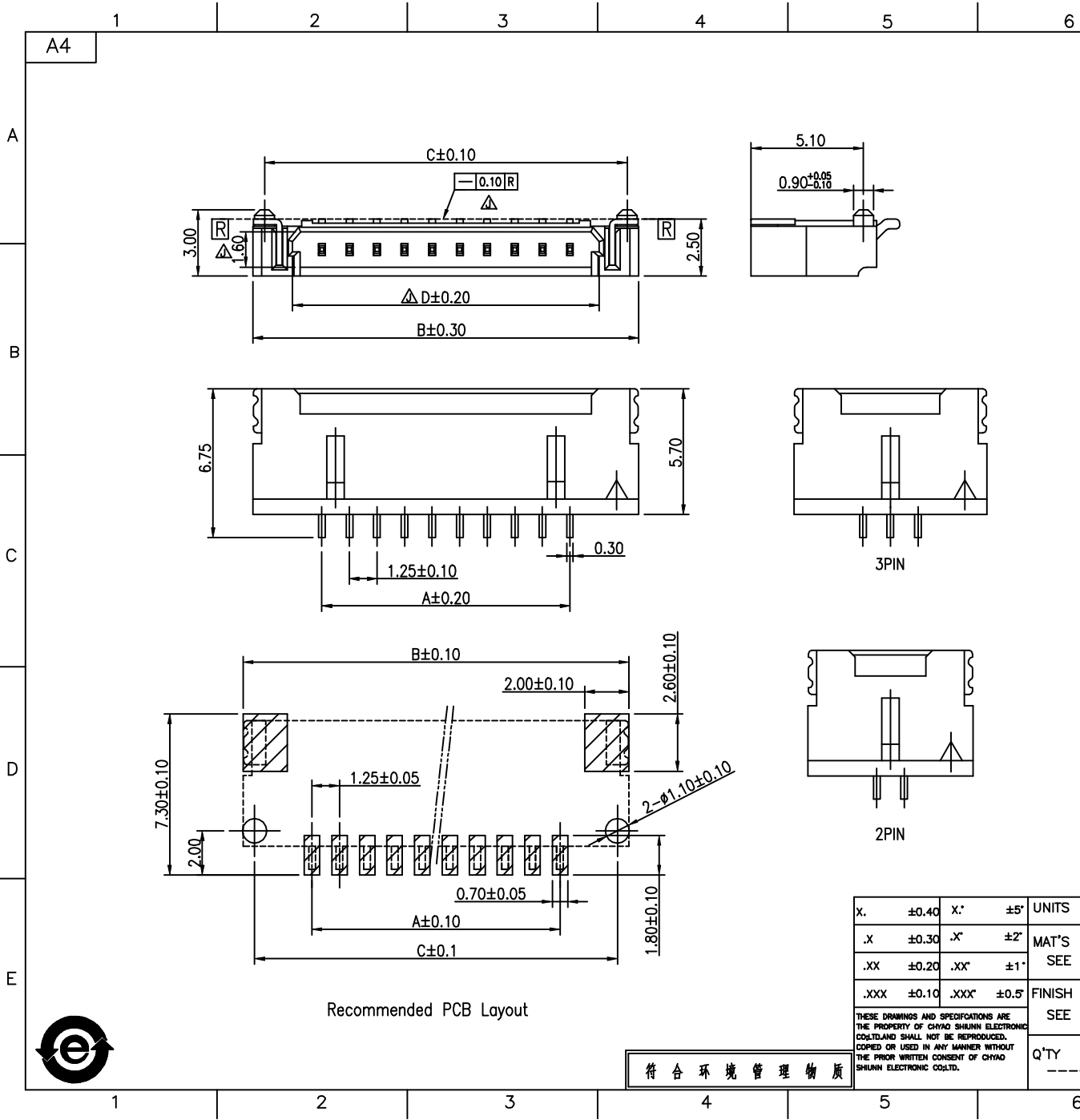

REV.	ECN.NO	REVISIONS	REV.DRAWN	DATE
G	---	PCB Layout 增加尺寸标注	sunquan	2011/05/25
H	---	增加镀金规格	sunquan	2011/07/22
I	---	补齐2~4P C尺寸数值	sunquan	2013/07/09
J	---	增加尺寸标注	Zuochao	2014/03/05
K	---	增加2/3PIN图示	zhangqiang	2019/10/10

WAFER:
 1. Material: Base: High Temp. Thermoplastic, UL94V-0
 Contact: Copper Alloy, Tin Plated/Gold Plated
 Ear: Copper Alloy, Tin Plated
 2. Q'ty : 1,500 Pcs/Reel
 3. Part No.
 JS-1235R-XXXX-XXXX-XX
 Poles: 2~30
 Blank: Tin Plated
 (M): Matte Sn
 GO: Gold Plated
 Blank: PA9T
 H1: PPA
 L1: LCP
 Blank: Normal
 NH: Halogen Free
 Blank: Nature
 Black: Black

Poles	Dimensions(mm)				Poles	Dimensions(mm)			
	A	B	C	D		A	B	C	D
02	1.25	7.50	6.45	3.90	17	20.00	26.25	25.20	22.65
03	2.50	8.75	7.70	5.15	18	21.25	27.50	26.45	23.90
04	3.75	10.00	8.95	6.40	19	22.50	28.75	27.70	25.15
05	5.00	11.25	10.20	7.65	20	23.75	30.00	28.95	26.40
06	6.25	12.50	11.45	8.90	21	25.00	31.25	30.20	27.65
07	7.50	13.75	12.70	10.15	22	26.25	32.50	31.45	28.90
08	8.75	15.00	13.95	11.40	23	27.50	33.75	32.70	30.15
09	10.00	16.25	15.20	12.65	24	28.75	35.00	33.95	31.40
10	11.25	17.50	16.45	13.90	25	30.00	36.25	35.20	32.65
11	12.50	18.75	17.70	15.15	26	31.25	37.50	36.45	33.90
12	13.75	20.00	18.95	16.40	27	32.50	38.75	37.70	35.15
13	15.00	21.25	20.20	17.65	28	33.75	40.00	38.95	36.40
14	16.25	22.50	21.45	18.90	29	35.00	41.25	40.20	37.65
15	17.50	23.75	22.70	20.15	30	36.25	42.50	41.45	38.90
16	18.75	25.00	23.95	21.40					

X.	±0.40	X'	±5'	UNITS	MM
.X	±0.30	.X'	±2'	MAT'S	CUSTOMER
.XX	±0.20	.XX'	±1'	SEE NOTE	PART NO.(INTENDED USE)
.XXX	±0.10	.XXX'	±0.5'	SEE NOTE	JS-1235R-XX
THESE DRAWINGS AND SPECIFICATIONS ARE THE PROPERTY OF CHIAO SHUNN ELECTRONIC CO.,LTD.AND SHALL NOT BE REPRODUCED, COPIED OR USED IN ANY MANNER WITHOUT THE PRIOR WRITTEN CONSENT OF CHIAO SHUNN ELECTRONIC CO.,LTD.					
Q'TY	----	APPV'D			
DR': hejihuai 2009/07/23					

客户 (CUSTOMER): 乔讯电子(上海)有限公司
 CHIAO SHUNN ELECTRONICS(SHANGHAI)CO.,LTD.
标题 (TITLE): 1.25mm Crimp Style Connectors
图号 (DWG NO.): 020-0026-1235R-XX
比例 (SCALE): 4 : 1
张数 (SHEET): 1/1
版本 (REV): /

符合环境管理物质



REV	ECN.NO.	REVISIONS	REV.DRAWN	DATE
C		增加电镀规格	YU	07-08/17
D	08017	增加三角凹形	Yuqilong	08-01/31
E		增加膜厚测点及电镀规格	hejihuai	09-04/27
F		修正图面与实物相符	sunquan	11-07/25

TERMINAL

Part No. : JS-1225-TXX
 (Stamping after plated) Blank: Tin Plated
 Sn>50μ Ni>10μ
 (Stamping before plated) 2: Tin Plated
 Sn>100μ Ni>30μ
 G0: Gold Plated
 Au>0.8μ Ni>30μ

- . Applicable Wires : AWG# 28~32
- . Material : Copper Alloy
- . Finish : Tin Plated/Gold Plated
- . Thickness : 0.15mm
- . Q'ty : 15,000 Pcs/Reel

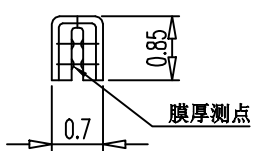
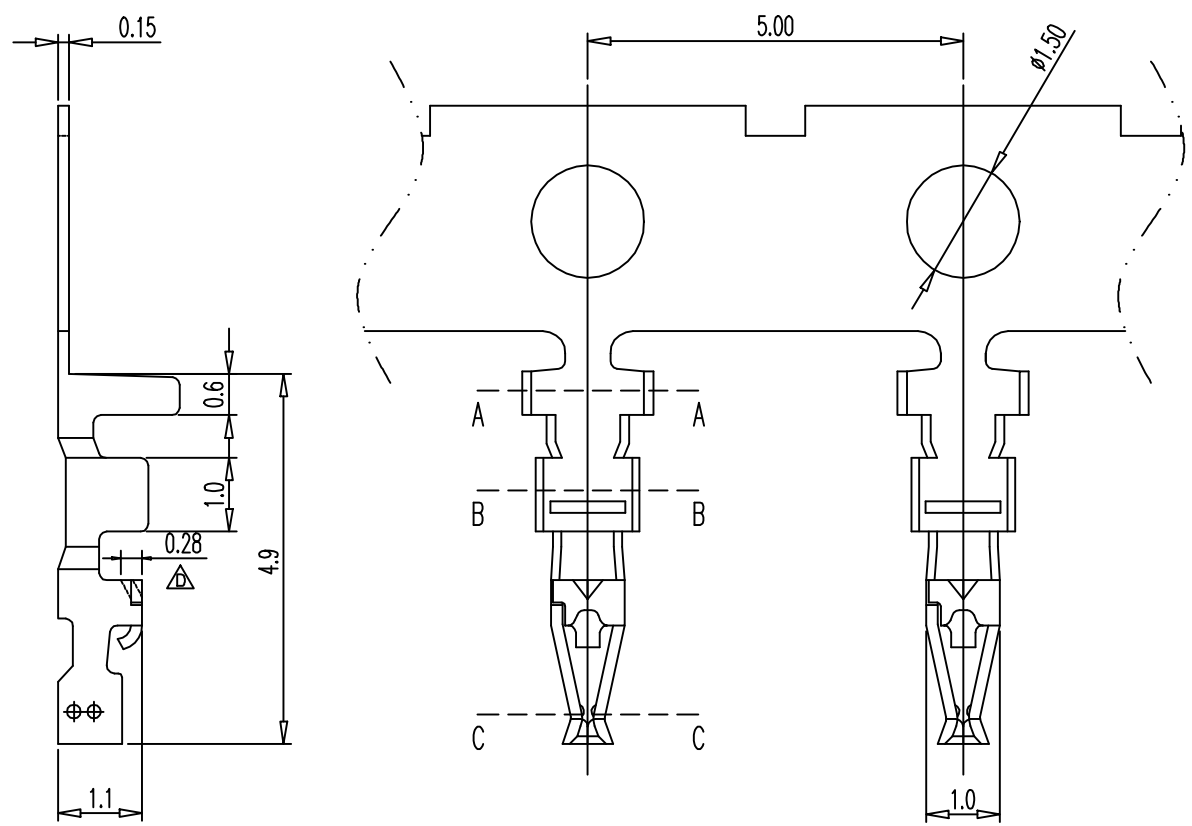

C-C SEC

B-B SEC

A-A SEC



符合环境管理物质

X.± 0.30	X°.± 5.0°	UNITS mm	NAME(INTENDED USE) CUSTOMER	CHYAO SHIUNN ELECTRONIC (SHANGHAI) CO.,LTD.	
.X± 0.15	.X°.± 2.0°				PART NO.(INTENDED USE) JS-1225-T
.XX± 0.07	.XX°.± 1.0°	TITLE: WIRE TO BOARD CONNECTOR			
.XXX± 0.03	.XXX°.± 0.5°	FINISH	APPD: liuzhiwen	11-07/25	DWG NO.: 020-0086-1225-T
THESE DRAWINGS AND SPECIFICATIONS ARE THE PROPERTY OF CHYAO SHIUNN ELECTRONIC CO., LTD. AND SHALL NOT BE REPRODUCED, COPIED OR USED IN ANY MANNER WITHOUT THE PRIOR WRITTEN CONSENT OF CHYAO SHIUNN ELECTRONIC CO., LTD.		Q'TY	CHKD:		SCALE SHEET REV. 2:1 1/1 F
			DR: HEJIHUI	09-04/27	

CHYAO SHIUNN ELECTRONIC (SHANGHAI) CO.,LTD.	TITLE: WIRE TO BOARD CONNECTOR
DWG NO.: 020-0086-1225-T	
APPD: liuzhiwen 11-07/25	CHKD:
DR: HEJIHUI 09-04/27	
SCALE SHEET REV. 2:1 1/1 F	