

REV	ECN.NO.	REVISIONS	REV.DRAWN	DATE
B		整理发行	SUN	04-11/10
C		增加PIN位	YU	07-12/27

SPECIFICATIONS

- . Voltage Rating : 150V AC/DC
- . Current Rating : 1A AC/DC
- . Withstanding Voltage : 500V AC/minute
- . Insulation Resistance ; 500MΩ min
- . Temperature Range : -35°C to +85°C
- . Contact Resistance : 20mΩ max

HOUSING

- . Part No. : JS-1255-XX
- . Poles : 2x5~2x25
- . Material : Nylon66 UL94V-0
- . Q'ty : 1,000 pcs/Bag

POLES	PART NO.	DIMENSIONS	
		A	B
10	JS-1255-2x05	5.00	8.00
20	JS-1255-2x10	11.25	14.25
30	JS-1255-2x15	17.50	20.50
40	JS-1255-2x20	23.75	26.75
50	JS-1255-2x25	30.00	33.00

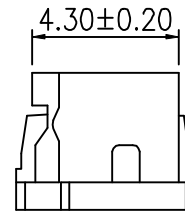
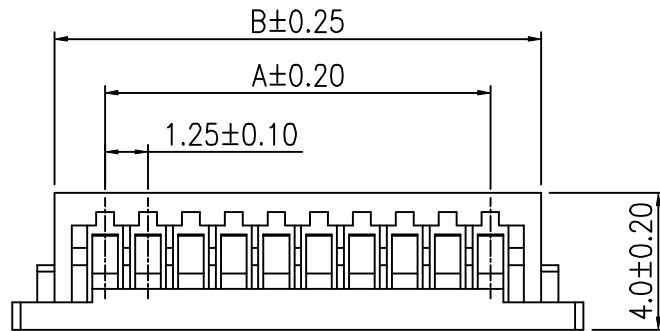
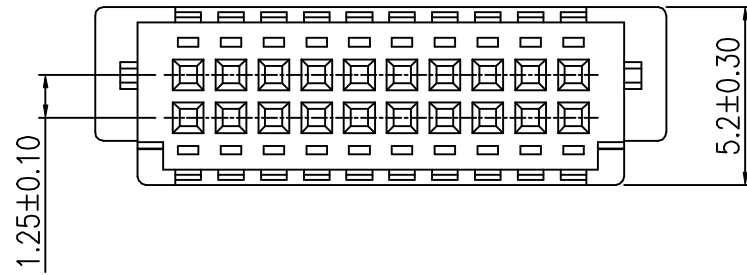

符合环境管理物质

X.± 0.50	X°.± 5.0°	UNITS	mm
.X± 0.30	.X°.± 2.0°	MAT'L	
.XX± 0.20	.XX°.± 1.0°	FINISH	
.XXX± 0.10	.XXX°.± 0.5°		
THESE DRAWINGS AND SPECIFICATIONS ARE THE PROPERTY OF CHYAO SHIUNN ELECTRONIC CO., LTD. AND SHALL NOT BE REPRODUCED, COPIED OR USED IN ANY MANNER WITHOUT THE PRIOR WRITTEN CONSENT OF CHYAO SHIUNN ELECTRONIC CO., LTD.			

NAME(INTENDED USE)		CHYAO SHIUNN ELECTRONIC (SHANGHAI) CO.,LTD.
CUSTOMER		
PART NO.(INTENDED USE)		TITLE:
JS-1255-XX		1.25mm Crimp Style Connector
APPD:		DWG NO.:
		020-0059-1255-XX
CHKD:	xuwei	07-12/27
DR:	YU	07-12/27

SCALE	SHEET	REV.
2:1	1/1	A

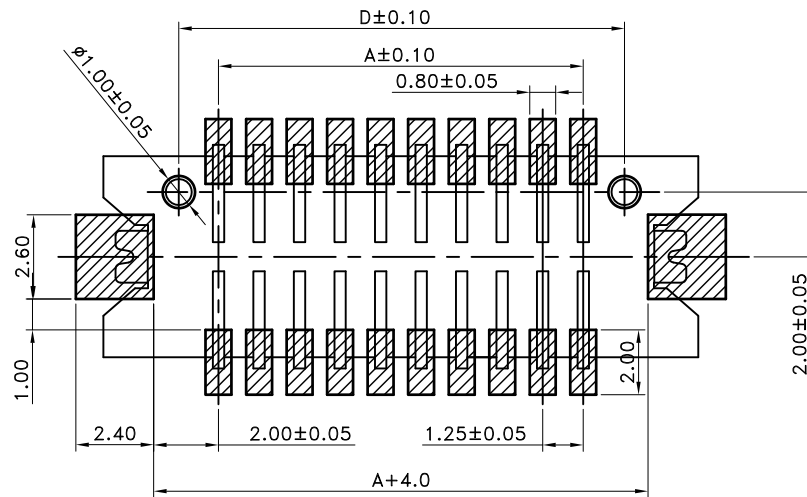
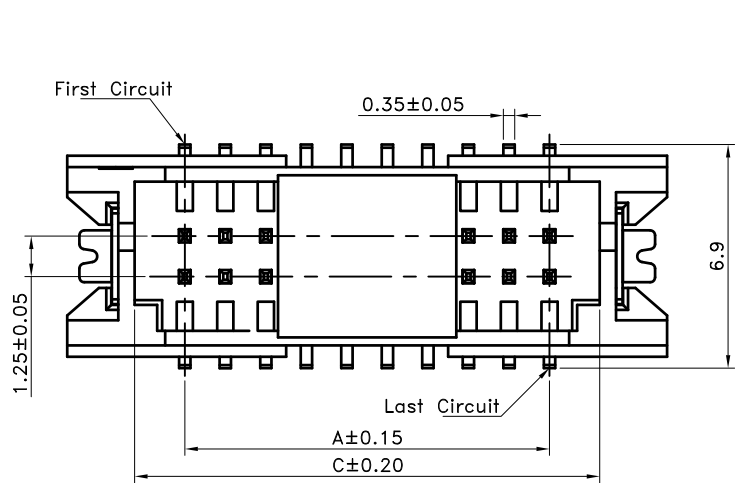

△14 Recommended P.C.B. Layout

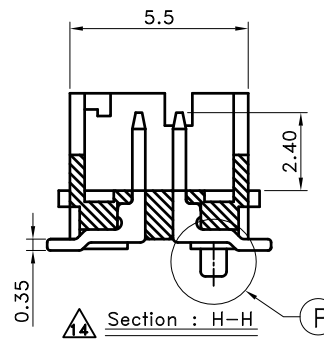
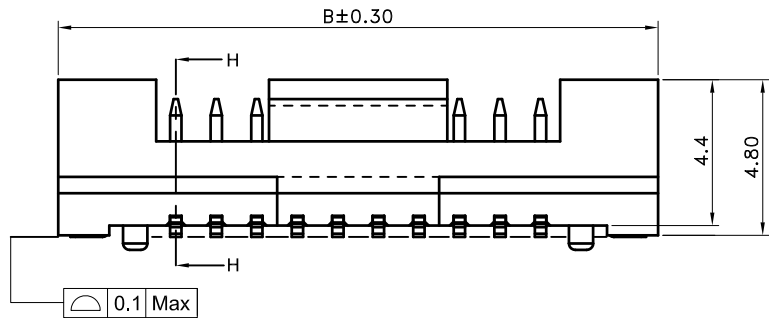

With Bulge(Standard) Without Bulge

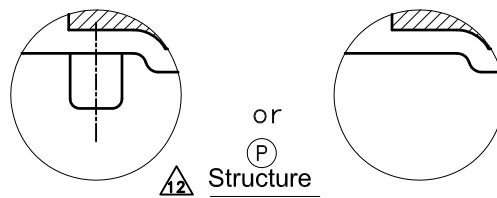

- SPECIFICATIONS
- Voltage Rating : 150V AC/DC
 - Current Rating : 1A AC/DC
 - Withstanding Voltage : 500V AC/minute
 - Insulation Resistance : 500MΩ min.
 - Temperature Range : - 35°C to + 85°C
 - Contact Resistance : 30mΩ max.

- WAFER
- Part No. : JS-1256-XXx2-XX(XX)-XX XX-XX
① ② ③ ④ ⑤ ⑥

- Code No :
- △13 ① Poles : 10,20,30,40
 - ② Bulge : Blank : With Bulge
△13 WB : Without Bulge
 - ③ Contact Plated : Blank : Gold
NM : Matte - Tin
 - ④ Base Material : Blank : Nylon PA 9T UL94V-0
H1 : Nylon PA 6T / 66 UL94V-0
 - ⑤ Base Color : Blank : Natural
BK : Black
 - ⑥ Halogen: Blank : Normal
NH : Halogen Free
 - Material : Contact : Phos.Bronze
Base : Refer Above Options
 - Packing : Tape/Reel

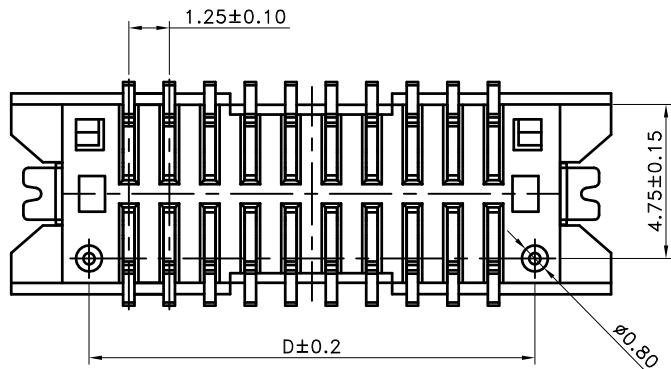

Poles	Dimension(mm)			
	A	B	C	D
10	5.00	12.10	8.10	7.50
20	11.25	18.35	14.35	13.75
30	17.50	24.60	20.60	20.00
40	23.75	30.85	26.85	26.25

 喬訊電子工業股份有限公司
CHYAO SHIUNN
ELECTRONIC INDUSTRIAL LTD.

APPROVED BY	SCALE	TOLERANCE	LTR	REVISION RECORD	NAME	DATE	LTR	REVISION RECORD	NAME	DATE
張育瑞	mm	.0 ±0.30	△14	ECR 201002-005	黃科源	2010/02/09				
CHECKED BY	PROJ	.00 ±0.20	△14	ECR 201002-005	林文泰	2010/02/09				
黃科源	PROJ	.000 ±0.10	△14	合併圖面	吳弘文	2012/06/20				
DRAWN BY	DATE	SIZE	ANGLE	修正無導柱編碼	吳弘文	2012/07/24				
吳弘文	2013/05/08	A4	0° ±1°	產品外觀&PIN數修正	吳弘文	2013/02/27				
			.0° ±	物性表Poles修正	吳弘文	2013/05/08				
			SHEET	1/1						

PART NO JS-1256-XXx2-XX(XX)-XXXX-XX

1.25mm Crimp Style Connectors Wafer <SMT>

CUSTOMER

Conforms to The RoHS Instruction

REV	ECN.NO.	REVISIONS	REV.DRAWN	DATE
E		整理发行	SUN	05-06/20
F		修正图面与实物相符	CARRY	09-02/05

SPECIFICATIONS

- . Voltage Rating : 150V AC/DC
- . Current Rating : 1A AC/DC
- . Withstanding Voltage : 500V AC/minute
- . Insulation Resistance : 500MΩ min
- . Temperature Range : -25°C to +85°C
- . Contact Resistance : 20mΩ max

TERMINAL

- . Part No : JS-1255-T
- . Applicable Wires : AWG#28-32
- . Material : Phos. Bronze
- . Finish : Tin Plated
- . Thickness : 0.15mm
- . Q'ty : 15,000pcs/Reel

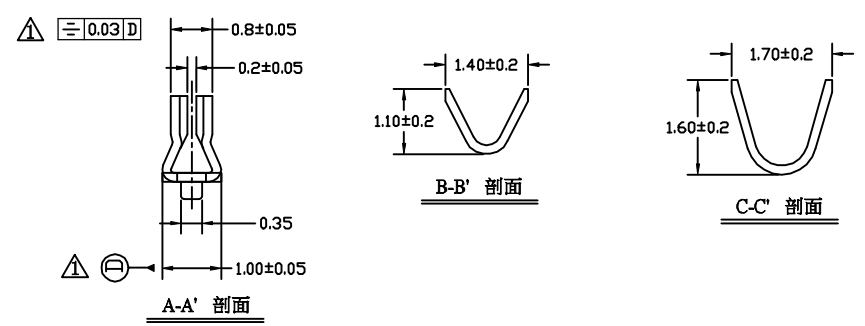
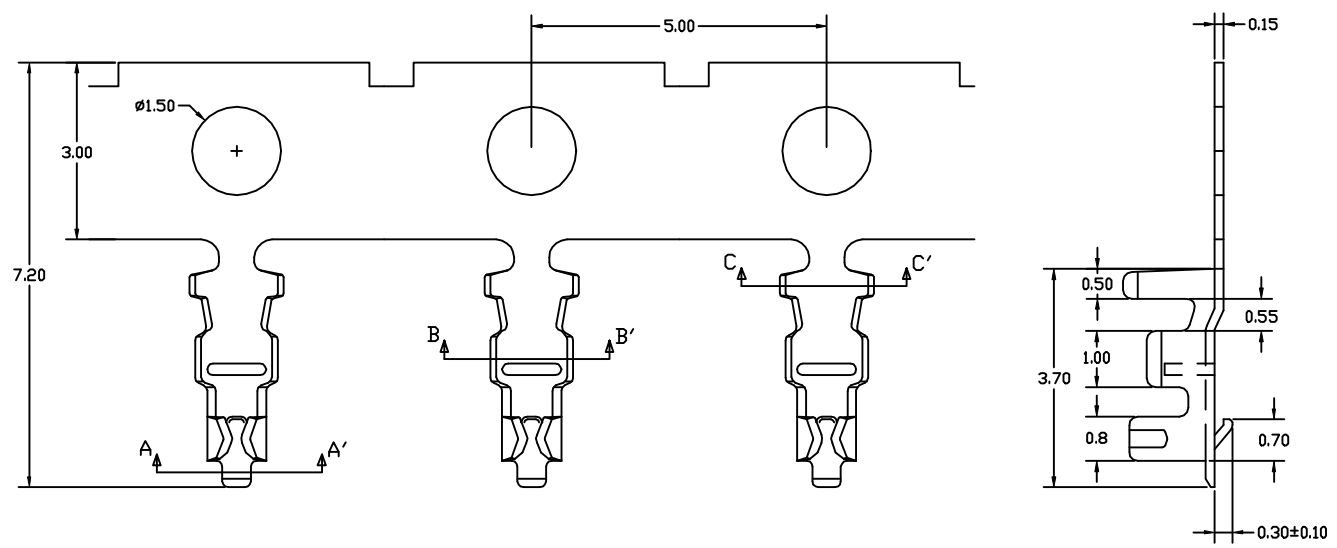

X.± 0.30	X°.± 5.0'	UNITS mm	NAME(INTENDED USE)		CHYAO SHIUNN ELECTRONIC (SHANGHAI) CO.,LTD.	
.X± 0.15	.X°.± 2.0'		CUSTOMER			
.XX± 0.07	.XX°.± 1.0'	FINISH	PART NO.(INTENDED USE)		TITLE:	
.XXX± 0.03	.XXX°.± 0.5'		JS-1255-T			WIRE TO BOARD CONNECTOR
THESE DRAWINGS AND SPECIFICATIONS ARE THE PROPERTY OF CHYAO SHIUNN ELECTRONIC CO., LTD. AND SHALL NOT BE REPRODUCED, COPIED OR USED IN ANY MANNER WITHOUT THE PRIOR WRITTEN CONSENT OF CHYAO SHIUNN ELECTRONIC CO., LTD.			APPD:		DWG NO.: 020-XXXX-1255-T	
			Q'TY			SCALE SHEET REV.
			CHKD: xuwei	09-02/05		
			DR: CARRY	09-02/05	2:1 1/1 F	



符合环境管理物质